



# V2V EDTECH LLP

Online Coaching at an Affordable Price.

## OUR SERVICES:

- Diploma in All Branches, All Subjects
- Degree in All Branches, All Subjects
- BSCIT / CS
- Professional Courses



**+91 93260 50669**



**v2vedtech.com**



**V2V EdTech LLP**



**v2vedtech**

## HEAD OFFICE



Secretary,  
Maharashtra State Board of Technical Education  
49, Kherwadi, Bandra (East), Mumbai - 400 051  
Maharashtra (INDIA)  
Tel: (022)26471255 (5 -lines)  
Fax: 022 - 26473980  
Email: -secretary @ msbte.com  
Web -www.msbte.org.in

### REGIONAL OFFICES:

#### MUMBAI

Deputy Secretary (T), Mumbai Sub-region,  
2<sup>nd</sup> Floor, Govt. Polytechnic Building,  
49, Kherwadi, Bandra (East)  
Mumbai - 400 051  
Phone: 022-26473253/ 54  
Fax: 022-26478795  
Email: rbtemumbai @ msbte.com

#### NAGPUR

Deputy Secretary (T),  
M.S. Board of Technical Education  
Regional Office,  
Mangalwari Bazar, Sadar, Nagpur - 440 001  
Phone: 0712-2564836 / 2562223  
Fax: 0712-2560350  
Email: rbteng @ msbte.com

#### PUNE

Deputy Secretary (T),  
M.S. Board of Technical Education,  
Regional Office,  
412-E, BahiratPatilChowk,  
Shivaji Nagar, Pune  
Phone: 020-25656994 / 25660319  
Fax: 020-25656994  
Email: rbtepn @ msbte.com

#### AURANGABAD

Deputy Secretary (T),  
M.S. Board of Technical Education,  
Regional Office,  
Osmanpura, Aurangabad -431 001.  
Phone: 0240-2334025 / 2331273  
Fax: 0240-2349669  
Email: rbteau @ msbte.com

# I

Name \_\_\_\_\_

Roll No. \_\_\_\_\_ Year 20 \_\_\_\_ 20 \_\_\_\_

SEMESTER I | DIPLOMA IN ENGINEERING AND TECHNOLOGY

## A LEARNING MANUAL

# FOR Basic Science (22102)

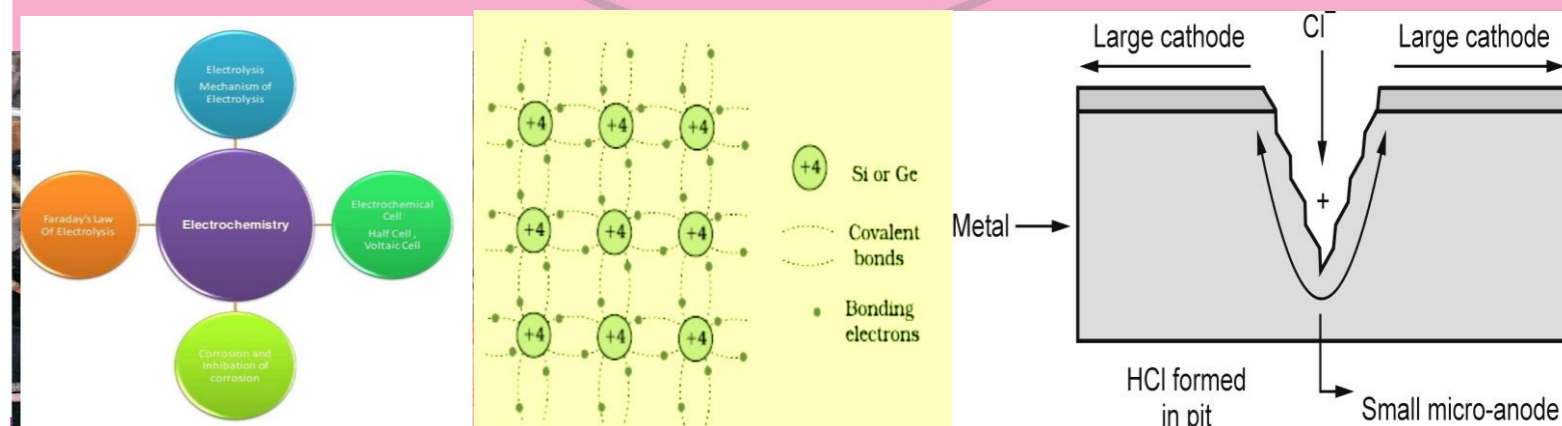

MAHARASHTRA STATE BOARD OF TECHNICAL EDUCATION, MUMBAI  
(Autonomous) (ISO 9001 : 2015) (ISO / IEC 27001 : 2013)

**A Learning Manual  
For  
Basic Science**

**(22102)  
Semester– (I)**

**(First Semester Diploma in Engineering and Technology)**

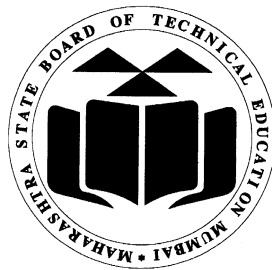

**Maharashtra State  
Board of Technical Education, Mumbai**  
**(Autonomous) (ISO-9001-2008) (ISO/IEC 27001:2013)**

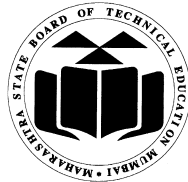

**Maharashtra State**  
**Board of Technical Education, Mumbai**  
**(Autonomous) (ISO-9001-2008) (ISO/IEC 27001:2013)**  
**4<sup>th</sup> Floor, Government Polytechnic Building, 49, Kherwadi,**  
**Bandra (East), Mumbai -400051.**

## **Preface**

The primary focus of any engineering work in the technical education system is to develop the much needed industry relevant competencies and skills. With this in view, MSBTE embarked on this innovative 'I' Scheme curricula for engineering diploma programmes with outcome-based education .

This Learning manual is designed to help all stakeholders, especially the students, teachers and instructors to develop in the student the pre-determined outcomes. The manual begins by identifying the competency, course outcomes,. The students will become aware about the concepts of Basic Science..

This manual also provides guidelines to teachers to effectively facilitate student-centered activities through each chapter by arranging and managing necessary resources ensuring the achievement of outcomes in the students.

Diploma engineers (also called technologists) have to deal with various materials and machines. This course is designed with some fundamental information to help the technologists apply the basic concepts and principles of physics and chemistry to solve broad based engineering problems. The study of basic principles of sciences and the concepts related to various materials such as metals, alloys, inorganic salts, polymers, lubricants, paints, varnishes, adhesives, heat, electricity, magnetism, optics, semiconductors and others will help in understanding the technology courses where emphasis is on the applications of these in different technology

The Learning manual development team wishes to thank MSBTE who took initiative in the development of curriculum re-design project and implementation and also acknowledge the contribution of individual course experts who have been involved in Learning manual as well as curriculum development (I scheme) directly or indirectly

Although all care has been taken to check for mistakes in this learning manual, yet it is impossible to claim perfection especially as this is the first edition. Any such errors and suggestions for improvement can be brought to our notice and are highly welcome.

**Learning Manual Development Team**

**List of Content**

<b>S. No</b>	<b>Name of Unit</b>	<b>Page No.</b>
<b>SECTION – I [PHYSICS]</b>		
<b>1.</b>	<b>Units and Measurements</b>	<b>05</b>
<b>2.</b>	<b>Electricity, Magnetism and Semiconductors</b>	<b>14</b>
<b>3.</b>	<b>Heat and Optics</b>	<b>38</b>
<b>SECTION – II [CHEMISTRY]</b>		
<b>4.</b>	<b>Chemical Bonding and Catalysis</b>	<b>64</b>
<b>5.</b>	<b>Metal Corrosion, its prevention and Electro chemistry</b>	<b>95</b>
<b>6.</b>	<b>Paint, Varnishes, Insulators, Polymer, Adhesives and Lubricants</b>	<b>134</b>

**SECTION – I [PHYSICS]**  
**Topic1**  
**Units and Measurements**

**CO** : Estimate errors in measurement of physical quantify

**UO:**

1. Describe the given measurement device and its application
2. Describe with justification the device used to measure radius of curvature of the given object.
3. State with justification the error in the given measurement
4. Determine the procedure to determine the dimensions of the given physical quantity

**Introduction/ Rationale**

Measurement of any physical quantity in valves comparison with certain basic measurement are used by scientist for understanding nature phenomenon, it is used by society for transaction in business and practical purposes. engineers use measurements in building drawing, control systems, data processing etc.

Unit is a standard in which a physical quantity is measured. The measurement of physical quantity is explored by a number accompanied by a unit. Ex 10 kg, 5 m  
 where 10= magnitude kg= unit 5= magnitude m= unit

The physical quantities are large in number, but we require limited number of units to express them, since they are related to one another.

**Significance**

All the devices used by engineers for measurement have magnitude and units and hence understanding of same is necessary for all branches of engineering

**Fundamental units/ base units.**

The units of fundamental quantities are called fundamental units fundamental quantifier are the physical quantities’, which do not depend on any other physical quantities for its measurements. There are seven base/ fundamental quantities with two more quantities (plane angle and solid angle)

Table 1.1

Sr. No.	Fundamental Physical Quantity	Fundamental Unit	Symbol
1	length	metre	m
2	mass	kilogram	kg

Sr. No.	Fundamental Physical Quantity	Fundamental Unit	Symbol
3	time	second	s
4	electric current	ampere	A
5	absolute temperature	kelvin	K
6	luminous intensity	candela	cd
7	amount of substance	mole	mol

### Derived units

The units of derived quantities are called as derived units derived quantities. These physical quantities are expressed as combination of one or more fundamental quantities.

Table 1.2

Derived Quantity	Formula	Derived units
Area	Length * Length	Square meter
Volume	Length * Length * Length	Cubic meter
Density	Mass/ Volume	$\text{Kg/m}^3$
Velocity and Speed	Length/ Time	m/s
Acceleration	Velocity/ Time	$\text{m/s}^2$
Force	Mass * Acceleration	$\text{kg m/s}^2$
Energy and Work	Force * Length	$\text{kg m}^2/\text{s}^2$
Power	Energy/ Time	$\text{kg m}^2/\text{s}^3$
Pressure and Thrust	Force/ Area	$\text{kg /m s}^2$
Momentum	Mass * Velocity	$\text{Kg m/s}$
Charge	Current * time	A s
Potential difference	Potential energy /charge	$\text{kg m}^2/\text{A s}^3$
Resistance	Potential difference / current	$\text{kg m}^2/\text{A}^2 \text{s}^3$



## Systems of Unit

The complete set of base/fundamental units and derived units is known as system of units. Different countries used different systems of units for measurement of physical quantity. The system of units is as following

The following system of units are in used

1. **C.G.S.** system. They are centimeter, gram, second respectively
2. **F.P.S.** system. They are foot pound second respectively
3. **M.K.S.** system. They are meter kilogram system
4. **S.I.** system. System international

The **S.I.** systems of units are now accepted worldwide for measurement.

## Multiples and Submultiples

A measurement is expressed in terms of units. However, sometimes it finds more convenient to express a measurement in terms of multiples and submultiples of unit. For example, meter is convenient unit to express the length of table but it is too small to express the distance between two cities. It is more convenient to express the diameter of wire in millimeters and distance between two cities in kilometers.

Thus Multiples and Submultiples of units are expressed by means of prefixes. Each prefix represents a multiplication factor in terms of a certain power of 10. Any measurement is expressed in a compact and convenient form by making use of an appropriate prefix for the unit. Thus while expressing very large as well as very small magnitude of physical quantity prefixes are used with unit of that physical quantity. They are called multiples and submultiples. Some of the most commonly used multiples and submultiples (prefixes) are listed below

Table 1.3

Symbol	Name	Factor	Symbol	Name	Factor
Y	yotta	$10^{24}$	y	yokto	$10^{-24}$
Z	zetta	$10^{21}$	z	zepto	$10^{-21}$
E	Exa	$10^{18}$	a	atto	$10^{-18}$
P	peta	$10^{15}$	f	femto	$10^{-15}$
T	tera	$10^{12}$	p	pico	$10^{-12}$
G	giga	$10^9$	n	nano	$10^{-9}$
M	mega	$10^6$	$\mu$	micro	$10^{-6}$
k	kilo	$10^3$	m	milli	$10^{-3}$
h	hecto	$10^2$	c	centi	$10^{-2}$
da	deka	$10^1$	d	deci	$10^{-1}$

Example:

- 1) 1 meter = x cm     $x = 100$  or  $10^2$
- 2) 1 mm = x m     $x = 0.001$  or  $10^{-3}$
- 3) 1 GHz = x MHz     $x = 1000$  or  $10^3$

### Dimension of physical quantity

The physical quantities are described by its dimension. The physical quantities represented by derived units can be expressed in combination of fundamental quantities. The dimension is denoted with square brackets [ ]. Thus length has dimensions [L], Mass [M], Time [T], electric current [A], Thermodynamic temperature [K], luminous intensity [cd] and amount of substance [mol]. The dimensions of physical quantities are the powers to which the fundamental quantities are raised to represent that quantity.

### Dimension formula

The expression, which shows how which of fundamental quantities represent dimensions of physical quantity is called the dimensional formula.

Table 1.4

Quantity	Formula	Dimensions	Dimensional Formula
Area	Length x Length	[L <sup>2</sup> ]	[L <sup>2</sup> M <sup>0</sup> T <sup>0</sup> ]
Volume	Length x Length x Length	[L <sup>3</sup> ]	[L <sup>3</sup> M <sup>0</sup> T <sup>0</sup> ]
Density	Mass/ Volume	[L <sup>-3</sup> M <sup>1</sup> ]	[L <sup>-3</sup> M <sup>1</sup> T <sup>0</sup> ]
Velocity and Speed	Length/ Time	[L <sup>1</sup> T <sup>-1</sup> ]	[L <sup>1</sup> M <sup>0</sup> T <sup>-1</sup> ]
Acceleration	Velocity/ Time	[L <sup>1</sup> T <sup>-2</sup> ]	[L <sup>1</sup> M <sup>0</sup> T <sup>-2</sup> ]
Force	Mass x Acceleration	[L <sup>1</sup> M <sup>1</sup> T <sup>-2</sup> ]	[L <sup>1</sup> M <sup>1</sup> T <sup>-2</sup> ]
Energy and Work	Force x Length	[L <sup>2</sup> M <sup>1</sup> T <sup>-2</sup> ]	[L <sup>2</sup> M <sup>1</sup> T <sup>-2</sup> ]
Power	Energy/ Time	[L <sup>2</sup> M <sup>1</sup> T <sup>-3</sup> ]	[L <sup>2</sup> M <sup>1</sup> T <sup>-3</sup> ]
Pressure and Thrust	Force/ Area	[L <sup>-1</sup> M <sup>1</sup> T <sup>-2</sup> ]	[L <sup>-1</sup> M <sup>1</sup> T <sup>-2</sup> ]
Momentum	Mass x Velocity	[L <sup>1</sup> M <sup>1</sup> T <sup>-1</sup> ]	[L <sup>1</sup> M <sup>1</sup> T <sup>-1</sup> ]
Power	Energy/ Time	[L <sup>2</sup> M <sup>1</sup> T <sup>-3</sup> ]	[L <sup>2</sup> M <sup>1</sup> T <sup>-3</sup> ]

### Errors

The result of every measurement by a measuring instrument contains some uncertainty. This uncertainty is called as error.

The accuracy and precision are two terms involved measurement. accuracy is a measure how close the measured value is to the true value while precision tells us to what resolution or limit the quantity is measured.

The errors are classified as instrumental systematic error, random errors.

### **Instrumental error**

The errors which arise due to imperfect design or calibration of measuring instrument. ex. In Vernier caliper zero mark may not coincide with zero mark of main scale. This error can be minimize by selecting better Instruments

### **Systematic errors**

These errors arise due to imperfection in experiment technique or procedure the pointer of voltmeter, which does not coincide with any mark.

### **Random errors**

The errors which occur due to unpredictable. Change in experimental conditions. Which cannot be controlled. Change in temperature, voltage fluctuation, etc. Significant figures It is a trust worthy digit in measurement of physical quantify . the significant figure is related to accuracy of measuring instrument more the significant figures is the accuracy in measurement

### **Rules for significant figures**

All the non-zero digits are significant figures

1. All the zero between non zero digit are digit are significant figures
2. If the number is less than, the zeros on the right of decimal point but to the left of non zero digit are not significant figures.  $0.\underline{00}28$  Underlined zero are not significant figures
3. The terminal, number without a decimal point are not significant figure(  $123\text{m}$ .  $12300\text{cm}=123000\text{mm}$ ) has 3 significant Figures trailing zero are not significant
4. The trailing zero in number with a decimal point are significant  $3.500$  or  $0.06900$  have four significant figure.
5. The number should be generally reported in scientific notation (ie power of 10 )

$$4.700\text{m} = 4.700 \times 10^2 \text{cm} = 4.700 \times 10^3 \text{mm} = 4.700 \times 10^{-3} \text{ km}$$

Power of 10 is irrelevant to determine significant figures.

However, the base number in the significant notation is significant thus there are 4 significant figures.

Table 1.5

<b>Sr. No.</b>	<b>Value</b>	<b>Number of significant Figures</b>
1	11.080	5
2	0.0196	3

3	200.0109	7
4	0.0005300	4
5	1.6×10 <sup>-19</sup>	2

**Estimation of error**

**Absolute errors**

Suppose the values obtained in the measurement are a<sub>1</sub>, a<sub>2</sub>, a<sub>3</sub>, a<sub>n</sub> the arithmetic mean of these values are taken as best possible value of quantity

$$a_{\text{mean}} = \frac{a_1 + a_2 + a_3 + \dots + a_n}{n}$$

**The magnitude of difference between the individual measurement and true of the quantity is called the absolute error of measurement |Δa|**

$$\Delta a_1 = a_1 - a_{\text{mean}}$$

$$\Delta a_2 = a_2 - a_{\text{mean}}$$

$$\Delta a_3 = a_3 - a_{\text{mean}}$$

: : :

: : :

$$\Delta a_n = a_n - a_{\text{mean}}$$

Δa calculated may be negative or positive but the absolute error is always taken positive.

Mean absolute error the mean of all absolute errors is called as mean absolute error Δa<sub>mean</sub>

$$\Delta a_{\text{mean}} = \frac{\Delta a_1 + \Delta a_2 + \Delta a_3 + \dots + \Delta a_n}{n}$$

**Relative error**

The relative error is the ratio of mean absolute error Δa<sub>mean</sub> to the mean value a<sub>mean</sub> of the measured quantify.

$$\text{Relative error} = \frac{\Delta a_{\text{mean}}}{a_{\text{mean}}}$$

**Percentage error**

The relative error expressed in percent is called as percentage error

$$\text{Percentage error} = \text{relative error} \times 100\%$$

$$= \frac{\Delta a_{\text{mean}}}{a_{\text{mean}}} \times 100\%$$

If the error ΔL in the measurement of length L then percentage error is given by,

*Percentage Error in the measurement of length*

$$L = (\Delta L/L) \times 100\% \dots\dots\dots(1)$$

If the error ΔL in the measurement of L then percentage error Ln is given by,

*Percentage Error in the calculation of*

$$L^n = n \times (\Delta L/L) \times 100\% \dots\dots\dots (2)$$

If the error  $\Delta L$  in the measurement of length  $L$ ,  $\Delta B$  in the measurement of breadth  $B$  then surface area given by  $A = L \times B$  and percentage error in the measurement of surface area is given by,

*Percentage Error in the calculation of A = % error in L + % error in B*  
*Percentage Error in the calculation of A =  $(\Delta L/L) \times 100 + (\Delta B/B) \times 100\%$  .....(3)*

If acceleration due to gravity using simple pendulum is given by  $g = 4\pi^2 L/T^2$ ,  $4\pi^2$  being constant are not considered in calculation hence percentage error in 'g' is given by,

*Percentage Error in the calculation of g = % error in L + 2(% error in T)*  
*Percentage Error in the calculation of g =  $(\Delta L/L) \times 100\% + 2 \times (\Delta T/T) \times 100\%$*

Example : In an experiment a vernier caliper of least count 0.01cm is used for measurement. The radius of the sphere measured was 2.0 cm. Find the percentage error in measurement of radius, area, volume of the sphere?

Solution :

The percentage in measuring the radius of the sphere is given by equation 1

*Percentage Error in the measurement of radius =  $(\Delta r/r) \times 100\%$*   
 $= (0.01/2) \times 100\%$   
 $= \mathbf{0.5\%}$

The percentage in measuring the area of the sphere is given by equation 2

Area of sphere is  $4\pi r^2$   $4\pi$  being constant are not considered in calculation

*Percentage Error in the calculation of  $r^2 = n \times (\Delta r/r) \times 100\%$*   
 $= 2(0.01/2) \times 100\%$   
 $= \mathbf{1\%}$

The percentage in measuring the volume of the sphere is given by equation 2

Area of sphere is  $(4/3)\pi r^3$   $(4/3)\pi$  being constant are not considered in calculation

*Percentage Error in the calculation of  $r^3 = n \times (\Delta r/r) \times 100\%$*   
 $= 3(0.01/2) \times 100\%$   
 $= \mathbf{1.5\%}$

**Example :** Find percentage error in measuring the density of wood cube. When the mass of the mass of the block is  $50 \pm 0.1g$  , and the length of the cube is  $2 \pm 0.01cm$ .

**Solution :**

Density of the wooden block is given as density = (mass /volume)

Volume of the block is  $V = L^3$

*Percentage Error in the calculation of density =  $(\Delta m/m) \times 100\% + 3 \times (\Delta l/l) \times 100\%$*   
 $= (0.1 /50) \times 100\% + 3 \times (0.01 /2) \times 100\%$

$$=0.2 + 1.5 = 1.7\%$$

### Application

1. Measurement of length breadth height of given object
2. Measuring the radius of circular object
3. Dimensional analysis to deduce relation between different physical quantities
4. Estimate error for quality control

### E learning website

<http://hyperphysics.phy-astr.gsu.edu/hbase/hframe.html>

[https://en.wikipedia.org/wiki/Unit\\_of\\_measurement](https://en.wikipedia.org/wiki/Unit_of_measurement)

<https://www.youtube.com/watch?v=HQdy2Z-GmdY>

[https://www.youtube.com/watch?v=k\\_CoXqKDyuQ](https://www.youtube.com/watch?v=k_CoXqKDyuQ)

### Sample MCQ

1. \_\_\_\_\_ of the following is the fundamental quantity?  
a) Meter                      B) length                      C) force                      d) speed

Ans (b)

2. There are \_\_\_\_\_ significant figure in  $0.26 \times 10^2$  m.  
2                      B) 3                      C) 4                      d) 1

Ans (a)

3. \_\_\_\_\_ is correct dimension of density.  
a)  $[L^{-1} M^1 T^0]$     b)  $[L^{-3} M^1 T^0]$     c)  $[L^3 M^1 T^0]$     d)  $[L^{-3} M^1 T^1]$

Ans (b)

4. Relative error is given as \_\_\_\_.  
a)  $\frac{\Delta a_{\text{mean}}}{a_{\text{mean}}}$                       b)  $\frac{\Delta a_{\text{mean}}}{a}$                       c)  $\frac{a_{\text{mean}}}{\Delta a_{\text{mean}}}$                       d)  $\frac{a_{\text{mean}}}{a}$

Ans (a).

5. \_\_\_\_\_ is not a system of units.  
C,G,S                      b) C.I.S                      c) M.K.S.                      d) S.I

Ans (a)

### Reference:

1. Physics Textbook part 1, J.V.Naralika, A.W.Joshi et al 11<sup>th</sup> NCERT New Delhi ISB N81-7450-508-3

### Self-learning

- 1 Read the definitions of fundamental units.

**Micro projects**

- 1 Measure the object using Vernier caliper of different least counts.
- 2 Measure the object using micrometer screw gauge of different least counts.
- 3 Measure the circular object using spherometer of different least counts.
- 4 List down various measuring instrument in your core programs

## **Topic 2**

### **Electricity, Magnetism and semiconductors.**

**Course outcomes** -Apply the principals of electricity and magnetism to solve engineering problems.

#### **Unit outcomes**

- a) Calculate electric field, potential, and potential difference of the given static charge.
- b) Describe the concept of given magnetic intensity and flux with relevant units.
- c) Explain the heating effect of the given electric current.
- d) Apply Laws of series and parallel combination in the given electric circuits.
- e) Distinguish the given conductor, semi-conductor and insulators on basis of energy bands.
- f) Explain IV characteristics and applications of given P-N junction diode.

#### **Introduction / Rationale**

The concepts of electricity and magnetism is the foundation of engineering and technology The devices for communication such as radio, television, electric motors, medical instruments, transportation are based on electricity and magnetism. Semiconductor devices are small in size, consume less power and have long life and reliability. The following topic we will introduce the basic concepts of semiconductor physics. Semiconductor basic of electronic gadgets

#### **Significance**

All devices like Electric motors, electrical equipment, transportation devices need knowledge and understanding of electricity and magnetism. Moreover, electronic gadgets such as mobiles, computers, power supplies, electronic circuits, sensors require understanding of semiconductors.

#### **2.1 Electric field and electric potential:**

We have experience that, when we remove out sweater in winter, we hear crackling sound, and the sweater appears to stick to our body. Similarly when dry hair is combed with a comb crackling sound is produced.

This is because of electric charges produced due to friction between two bodies. Due to friction, electrons get transferred from one substance to other substance, making them charged.

There are two types of charges. The substance receiving electrons becomes negatively charged and the other which losses electrons become positively charged. Charge is measured in coulomb.



**2.1.1: Coulomb's Inverse Square Law:-**

There are two types of charges, namely, positive and negative Charges. It was observed that-

- Like charges repel each other and unlike charges attract each other.
- The force of attraction or repulsion between two charge  $q_1$  and  $q_2$  separated by distance 'r' is given by –

$$F \propto q_1 q_2$$

$$F \propto \frac{1}{r^2}$$

$$F \propto \frac{q_1 q_2}{r^2}$$

$$F = K \frac{q_1 q_2}{r^2} \quad \dots (1)$$

K is a constant of proportionality depends on the nature of medium.

$$K = \frac{1}{4 \pi \epsilon_0 \epsilon_r}$$

Where,

$$\epsilon_0 \rightarrow \text{Permittivity of free space} = 8.854 \times 10^{-12} \text{ F/m}$$

$$\epsilon_r \rightarrow \text{Relative permittivity of the medium between two charges} = 1 \text{ for air}$$

Above equation (1) becomes

$$F = \frac{q_1 q_2}{4 \pi \epsilon_0 r^2} \quad \dots (2)$$

In equation (2), if  $q_1 = q_2 = 1 \text{ C}$

And if  $r = 1 \text{ m}$ , we have

$$F = \frac{1}{4 \pi \epsilon_0} = 8.99 \times 10^9 \text{ N} = 9 \times 10^9 \text{ N}$$

From this we can define one coulomb or unit charge. It is that charge which when placed in air at a distance of 1m from and equal and similar charge, experiences a force of  $8.99 \times 10^9 \text{ N}$

**Example:** The distance between the electron and proton in the atom is  $5.8 \times 10^{-11} \text{ m}$ . Calculate the electrostatic force between them.

Given  $\epsilon_r = 1$  and charge on electron =  $1.6 \times 10^{-19} \text{ C}$

Formula:

$$F = 9 \times 10^9 \times \frac{q_1 q_2}{r^2}$$

$$F = 9 \times 10^9 \times \frac{1.6 \times 10^{-19} \times 1.6 \times 10^{-19}}{(5.8 \times 10^{-11})^2}$$

$$F = 6.84 \times 10^{-8} \text{ N}$$

**2.1.2: Electric field**

A charged body placed near a charge will experience a force. The region in which a charge experiences a force is called electric field.

**2.1.3 : Electric field Intensity**

Consider a charge of 'q' coulomb. Electric field intensity at point A in its electric field is the force experienced by unit positive charge placed at that point.

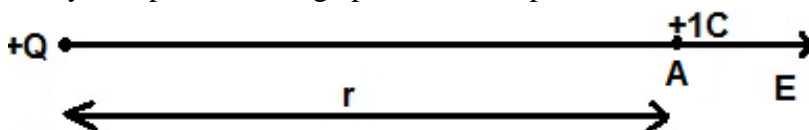
**Fig:2.1.3**

$$E = \frac{F}{q}$$

In above **Fig:2.1.3** the electric intensity at point A is given by

$$\text{Intensity} = \frac{\text{Force}}{\text{charge}}$$

$$\epsilon = \frac{1}{4\pi \epsilon_0 \epsilon_r} \frac{q}{r^2} \quad \text{for air } \epsilon_r = 1$$

$$\epsilon = \frac{1}{4\pi \epsilon_0} \frac{q}{r^2}$$

$$\epsilon = 9 \times 10^9 \frac{q}{r^2}$$

Electric Intensity is measured in N/C

**Example:** A charged sphere of 60 micro coulomb is placed in air. Find the electric field intensity at a point 30cm from the center of sphere.

Given :-

$$q = 60\mu\text{c} = 60 \times 10^{-6} \text{ c}, \quad r = 30 \text{ cm} = 0.3\text{m}, \quad \epsilon_r = 1$$

$$\epsilon = 9 \times 10^9 \times \frac{q}{r^2}$$

$$\epsilon = 9 \times 10^9 \times \frac{60 \times 10^{-6}}{(0.3)^2}$$

$$\epsilon = 6 \times 10^6 \text{ N/C}$$

**2.1.4 : Electric potential**

Consider a point charge + q Let A is the point in its electric field. Imagine a unit positive charge at infinity as shown in Fig : 2.1.4.1

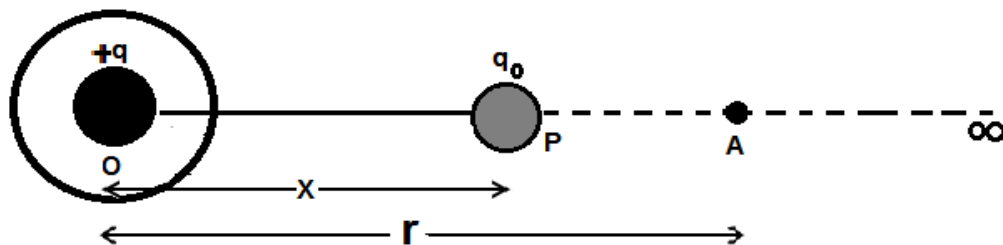

Fig : 2.1.4.1

The electric potential at point A is the amount of work done in bringing unit positive charge from infinity to that point against the electric field

$$\text{Electric potential} = \frac{\text{work done}}{\text{charge}}$$

$$V = \frac{w}{q}$$

The S.I. unit of potential is joule/ coulomb

The potential at point A is,

$$V_A = \frac{1}{4 \pi \epsilon_0 \epsilon_r} \times \frac{q}{r} = \text{----- For air}$$

$$V = 9 \times 10^9 \times \frac{q}{r}$$

**One volt:**

$$1 \text{ volt} = \frac{1 \text{ joule}}{1 \text{ coulomb}}$$

The potential at point is said to be one volt if one joule of work is done in bringing unit positive charge from infinity to that point.

**Concept of potential difference:**

Consider two water containers A and B, Connected by a tube. The water will flow through the tube only when there is a water level difference between A and B.

As water level is the factor deciding the flow of water, similarly charge level i.e. potential is the factor which decides the flow of charges.

Consider a point charge  $+q$  as shown in **Fig: 2.1.4.2**. A and B are two points in the electric field of charge  $+q$ .

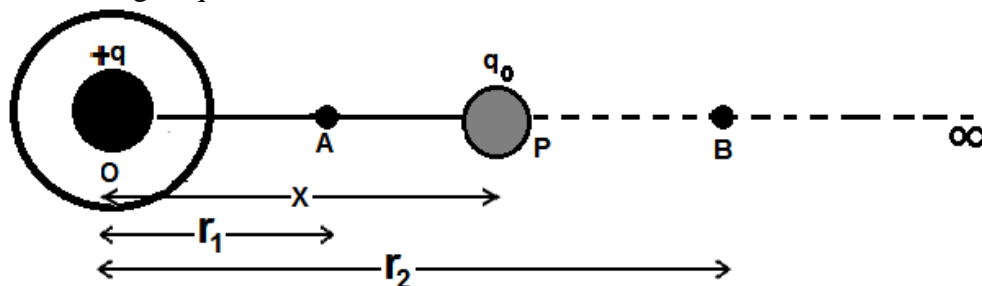

Fig : 2.1.4.2

Potential difference between the two points A and B is the work done in bringing unit positive charge from point B to point A

The potential at point A is given by,

$$V_A = \frac{1}{4\pi\epsilon_0\epsilon_r} \frac{q}{r_1}$$

The potential at point B is,

$$V_B = \frac{1}{4\pi\epsilon_0\epsilon_r} \frac{q}{r_2}$$

The potential difference between A and B is,

$$V = V_B - V_A$$

$$V = \frac{1}{4\pi\epsilon_0\epsilon_r} \times \left( \frac{q}{r_2} - \frac{q}{r_1} \right)$$

$$V = 9 \times 10^9 \times \left( \frac{q}{r_2} - \frac{q}{r_1} \right)$$

Example : Calculate the potential at point 10 cm away from a

charge of  $300 \mu\text{C}$ , in air

Given :

$$Q = 300 \mu\text{C} = 30 \times 10^{-6} \text{ C}$$

$$r = 10 \text{ cm} = 0.1\text{m}, \epsilon_r = 1$$

Formula :-

$$\begin{aligned} V &= 9 \times 10^9 \times \frac{Q}{r} \\ &= 9 \times 10^9 \times \frac{300 \times 10^{-6}}{0.1} \\ &= 27 \times 10^4 \text{ V} \end{aligned}$$

## 2.2 Magnetism

In physics, magnetism is defined as the property by virtue of which a magnetic material is able to create an attraction or repulsion force. It is the behavior of matter in magnetic field.

Magnetism is a force that can attract or repel objects that have a magnetic material like iron inside them magnetism is caused by the motion of electric charges. Every substance is made up of tiny units called atoms. Each atom has electrons, particles that carry electric charges.

The first magnet was discovered from a naturally occurring mineral called magnetite. A material with its molecular alignment has one effective North Pole and an effective South Pole.

The most basic law of magnetism is that like poles repel each other and unlike poles attract each other. If a bar magnet is broken, into two or more pieces then each piece behaves like an independent magnet with somewhat weaker magnetic field. When a bar magnet/ magnetic needle is suspended freely or is pivoted, it aligns itself in geographically North-South direction.

**2.2.1 Magnetic field:** - A magnetic field can be produced by either movement of charge or a magnetized material .The region around a magnetic material or a moving electric charge within which the force of magnetism acts. Magnetic field has magnitude and direction at each point. So it is a vector field. Magnetic field is denoted as 'B' .Its SI unit is tesla (T) and CGS unit is gauss.

### 2.2.2 Magnetic field intensity (H)

Intensity of a magnetic field is the force which a unit North Pole experiences when placed within the magnetic field. Number of magnetic lines passing through unit area is called

magnetic field intensity. It is also called magnetic field strength or magnetizing force. Its unit is ampere/ meter (A/M) or ampere turn.

### 2.2.3 Magnetic lines of force

These are imaginary lines representing direction of magnetic field such that the tangent at any point is the direction of the field vector at that point. The path along which unit North Pole moves when placed in magnetic field is called magnetic lines of force.

#### 2.3.1 Properties of magnetic lines of force

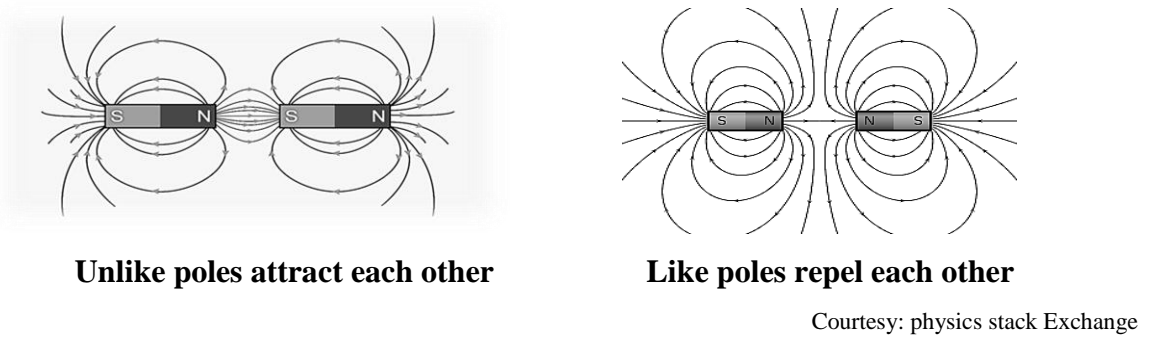

- 1) The magnetic lines of force of a magnet or a solenoid form closed loops.
- 2) Magnetic lines of force originate from North Pole and end at the South Pole outside the magnet.
- 3) The direction of magnetic field within a magnet is from South Pole to North Pole.
- 4) They never intersect each other.
- 5) The magnetic field strength is proportional to magnetic line density.
- 6) The magnetic field is tangent to the magnetic lines of force.
- 7) The magnetic lines of force are denser near the north or south poles indicating large value of magnetic field.
- 8) All the lines of force have same strength.

### 2.2.4 Magnetic Flux

It is the number of magnetic field lines passing through a closed loop surface.

Or

The amount of magnetic lines of forces set up in magnetic circuit is called magnetic flux.

It is analogous to electric current in electric circuit.

SI unit of magnetic flux is weber (wb)

The description of magnetic flux allows engineers to easily calculate voltage generated by an electric generator even when the magnetic field is complicated. If we choose a simple flat surface with area 'A' as our test area and there is an angle 'Θ' between normal to the surface and magnetic field vector (B) then magnetic flux is given by

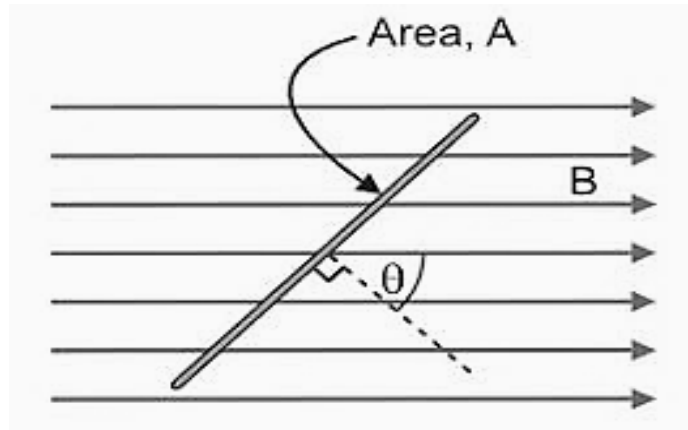

**Fig 2.2.4** (Courtesy: IB physics: Magnetic flux, Saburchill.com)

**Example:** A circular antenna of area  $3\text{m}^2$  is installed at a point. The plane of the area of antenna is inclined at  $47^\circ$  with the direction of earth's magnetic field. If magnitude of earth's magnetic field at a place is  $40773.9\text{ nT}$ . Find magnetic flux linked with antenna.

$$B = 40773.9\text{ nT} = 40773.9 \times 10^{-9}\text{ T}$$

$$\theta = 90 - 47 = 43^\circ$$

$$A = 3\text{ m}^2$$

$$\phi = B A \cos\theta$$

$$\phi = 40.773.9 \times 10^{-9} \times 3 \times \cos 43^\circ$$

$$\phi = 89.47 \times 10^{-6}\text{ wb}$$

$$\phi = 89.47\ \mu\text{ Wb}$$

## 2.3 : Current Electricity

### 2.3.1: Electric Current:

Consider a metal rod AB as shown in **Fig 2.3.1.1**. There are number of free electrons moving randomly. The number of electrons moving in one particular direction is same as the number of electrons moving in exactly opposite direction. As a result the net number of electrons passing in direction is zero.

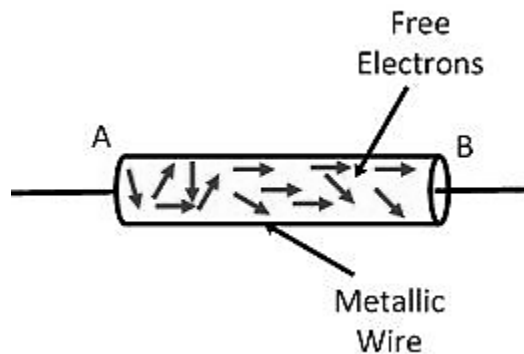

**Fig 2.3.1.1** (Courtesy: Circuit Globe)

Now if potential difference is applied across the conductor AB, by connecting battery or cell as shown in **Fig 2.3.1.2** below, all the electrons will move towards the positive terminal of the battery. We say the current is flowing through the conductor.

The conventional direction of current I opposite to the direction of flow of electrons

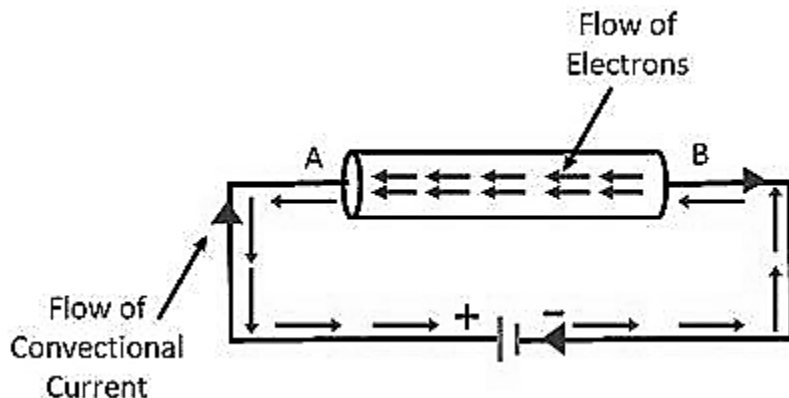

**Fig 2.3.1.2** (Courtesy: Circuit Globe)

The rate of flow of charge through a conductor is called as current  
 If, 'Q' is charge flowing through the conductor in time 'T' second  
 Then,

$$\text{Current} = \frac{\text{Charge}}{\text{Time}}$$

$$I = \frac{Q}{T} \quad \text{the unit of current is ampere.}$$

$$1 \text{ ampere} = \frac{1 \text{ Coulomb}}{1 \text{ second}}$$

One ampere is the current flowing through the conductor, when one coulomb charge is flowing through the conductor in one second.

When the electrons are flowing through the conductor, the motion of electrons is opposed by the conductor.

This opposition offered by the conductor to the flow of current is called as resistance.

A good conductor have low resistance and poor conductor has high resistance

### 2.3.2: Ohm's law

According to ohm' law, the current flowing through the conductor is directly proportional to potential difference applied across its ends, provided physical state of the conductor ( material, length, cross-sectional area, temperature) remains same. If, 'I' is current flowing through the conductor and 'V' is the potential difference across the conductor then,

$$\text{Then } V \propto I$$

$$V = IR$$

Where,

R is the constant called as resistance of the conductor. The value of R depends on the nature, dimension, and temperature of the conductor

$$\text{Resistance} = \frac{\text{Potential}}{\text{Current}}$$

The unit of resistance is ohm ( $\Omega$ )

$$R = \frac{V}{I}$$

$$\text{One ohm} = \frac{1 \text{ volt}}{1 \text{ ampere}}$$

One ohm is the resistance, when one ampere current is flowing through a conductor and the potential difference of one volt is applied across the conductor.

### 2.3.3: Specific resistance or resistivity ( $\rho$ )

When temperature & nature of material of conductor remain same, the resistance of a conductor depends on :

(1) Length :- It is observed that resistance of the conductor is directly proportional to its length.

$$R \propto L$$

(2) Area of cross-section:- the resistance of the conductor is inversely proportional to its cross-sectional area.

$$R \propto \frac{1}{A}$$

$$\text{Therefore, } R \propto \frac{L}{A}$$

$$R = \text{constant} \times \frac{L}{A}$$

$$R = \rho \times \frac{L}{A}$$

Where ‘ $\rho$ ’ is constant of proportionality, called as resistivity or specific resistance of the conductor, It depend on nature of conductor and temp,

$$\rho = \frac{R \times A}{L}$$

If  $A = 1 \text{ m}^2$  and  $L = 1 \text{ m}$  then  $\rho = R$

Specific resistance of the material is the resistance of that material having unit length and unit cross- section area. Unit of  $\rho$  is  $\Omega \text{ m}$

### Conductance: -

Conductance is the reciprocal of resistance.

$$\text{Conductance} = \frac{1}{\text{Resistance}}$$

The unit of conductance is mho ( $\Omega^{-1}$ )

### Effect of temperature on resistance:-

Resistance of conductor increases with increase in temperature.



i. e.  $R \propto \text{temperature}$

In case of bad conductors of electricity, resistance decreases with increase in temperature.

### 2.3.4 : Law of series combination of resistances

Consider three resistances  $R_1$ ,  $R_2$  and  $R_3$  connected end to end as shown in **Fig. 2.3.4**. This is called as series combination.

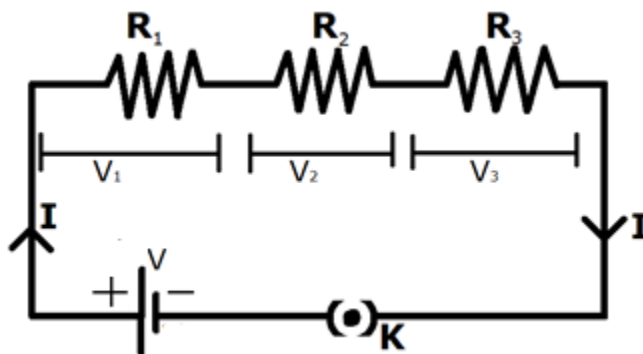

**Fig. 2.3.4**

- $I \longrightarrow$  Current flowing through each resistance
- $V \longrightarrow$  Total voltage applied across series combination
- $V_1 \longrightarrow$  Voltage drop across  $R_1$
- $V_2 \longrightarrow$  Voltage drop across  $R_2$
- $V_3 \longrightarrow$  Voltage drop across  $R_3$

We have by ohm's law

$$V = IR \text{ -----}$$

Similarly ,

$$V_1 = IR_1$$

$$V_2 = IR_2$$

$$V_3 = IR_3$$

$$\text{But, } V = V_1 + V_2 + V_3$$

Substituting these values in above equation,

$$IR = IR_1 + IR_2 + IR_3$$

$$R_s = R_1 + R_2 + R_3$$

This is the effective resistance of series combination.

#### **Law of resistance in series combination:**

It states that the effective resistance offered by two or more resistors connected in series combination is the algebraic sum of resistances of the individual resistors.

### 2.3.5 : Law of parallel combination of resistances

Consider three resistances  $R_1$ ,  $R_2$  and  $R_3$  connected as shown in **Fig. 2.3.5**. This is called as parallel combination.

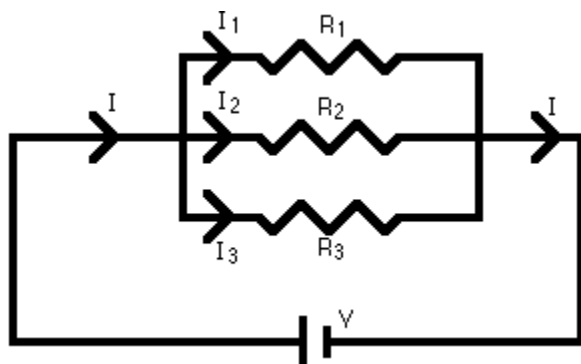

**Fig. 2.3.5**

- $I$  → Total current flowing through each resistance
- $V$  → Total voltage applied across parallel combination
- $I_1$  → Current flowing through resistor  $R_1$
- $I_2$  → Current flowing through resistor  $R_2$
- $I_3$  → Current flowing through resistor  $R_3$

We have by ohm's law

$$I = \frac{V}{R}$$

Similarly

$$I_1 = \frac{V}{R_1}$$

$$I_2 = \frac{V}{R_2}$$

$$I_3 = \frac{V}{R_3}$$

But, in parallel circuit current gets divided.

Therefore total current,

$$I = I_1 + I_2 + I_3$$

$$\frac{V}{R} = \frac{V}{R_1} + \frac{V}{R_2} + \frac{V}{R_3}$$

$$\frac{1}{R_p} = \frac{1}{R_1} + \frac{1}{R_2} + \frac{1}{R_3}$$

This is the effective resistance of parallel combination.

**Law of resistance in parallel combination:**

It states that the reciprocal of effective resistance offered by two or more resistors connected in parallel combination is equal to the algebraic sum of the reciprocals of the resistances of individual resistors.

**2.3.6: Heating effect of electric current**

**Introduction:**

When an electric current is passed through a conductor, the conductor becomes hot after some time and produce heat. This happens due to the conversion of some electric energy passing through the conductor into heat energy. This effect of electric current is called heating effect of current.

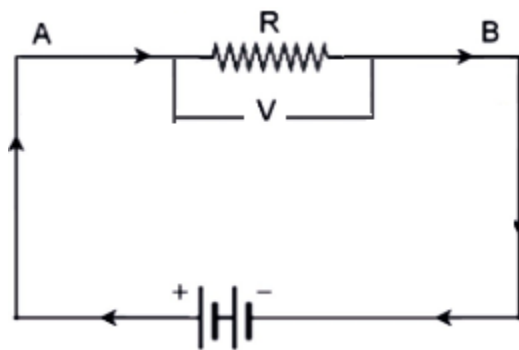

**Fig 2.3.6**

The heating effect of current was studied experimentally by Joule in 1941. After doing his experiments Joule came to the conclusion that heating effect of an electric current depends on three factors:

1. The resistance, R of the conductor. A higher resistance produces more heat.
2. The time, t for which current flows. The longer the time the larger the amount of heat produced
3. The amount of current, I. the higher the current the larger the amount of heat generated.

Statement of Joule’s law:

When current flows through a conductor, the heat produced in a conductor is directly proportional to the product of square of current ( $I^2$ ), resistance of the conductor (R) and the time (t) for which current is passed. Thus,

$$H \propto I^2Rt$$

**Derivation of Formula**

To calculate the heat produced in a conductor, consider current I is flowing through a conductor AB of resistance R for time t. also consider that the potential difference applied across its two ends is V.

Now, total amount of work done in moving a charge q from point A to B is given by:

$$W = q \times V \dots\dots\dots (1)$$

Now, we know that charge = current  $\times$  time

or  $q = I \times t$

and  $V = I \times R \dots\dots\dots(\text{Ohm's law})$

Putting the values of q and V in equation (1), we get

$$W = (I \times t) \times (I \times R)$$

Or  $W = I^2Rt$

Now, assuming that all the work done is converted into heat energy we can replace symbol of ‘work done’ with that of ‘heat produced’. So,

$$H = I^2RT$$

This equation is called the Joule’s equation of electrical heating.

### Applications of Heating Effect of Current

The heating effect of current is used in various electrical heating appliances such as electric bulb, electric iron, room heaters, geysers, electric fuse etc.

#### Electrical energy and power

The work done in pushing a charge round an electrical circuit is given by

$$W = V \times I \times t$$

So that power,  $P = \frac{W}{t} = V \times I$

The electrical power consumed by an electrical appliance is given by

$$P = V \times I = I^2R = \frac{V^2}{R}$$

**Example:** An electrical bulb is labeled 100W, 240V. Calculate:

1. The current through the filament when the bulb works normally
2. The resistance of the filament used in the bulb.

**Solution:**

$$I = \frac{P}{V} = \frac{100}{240} = 0.4167 \text{ A}$$

$$R = \frac{P}{I^2} = \frac{100}{(0.4167)^2} = 576.04 \Omega$$

## 2.4 :Semiconductors

### 2.4.1: Conductors

The material which allow electric current to flow through them easily are called conductor. All metals are almost good conductor like gold, silver, copper, aluminum etc. Conductor possess larger numbers of free electrons. They possess very low resistivity ( $\rho$ ) or they have high conductivity ( $\sigma$ )

### 2.4.2 : Insulators

The material which does not allow electric current to flow through them are called insulators. The electrons are tightly bounded to their nucleus as such there are no free electrons to move and conduct electricity. All nonmetals are insulators like quartz, mica, glass, rubber etc. They have high resistivity or they have low conductivity.

### 2.4.3: Semiconductor

The material which has conductivity in between metal & insulator is called semiconductor. The semiconducting materials are neither conductor nor insulator like germanium, silicon, carbon etc. Semiconductors are insulators at low temperature and act as conductors at high temperature. They have resistivity or conductivity intermediate to metals & insulators.

### 2.4.4: Electron volt:

The kinetic energy gained by an electron when accelerated through potential difference of one volt is called as one electron volt.

Energy gained by charged particle = magnitude of charge \* potential difference

$$\begin{aligned} 1\text{eV} &= \text{charge on electron} * 1 \text{ volt} \\ &= 1.6 * 10^{-19} * 1\text{V} \\ &= 1.6 * 10^{-19} \text{ J} \end{aligned}$$

### 2.4.5: Valance band ( $E_v$ )

The electron in the outermost shell are called as valance electron. The band formed by the series of energy levels containing the valance electrons is known as valance band. The valance band may also be defined as a band which is occupied by the valance electrons. A valance band has highest occupied band energy. The valance band may be partially or completely filled depending upon nature of crystal.

### 2.4.6: Conduction band ( $E_c$ )

After the valance band the next higher band is conduction band. The electrons occupying this band are known as conduction electrons or free electrons. The conduction band may also be defined as the lowest unfilled energy band. The band may be empty or partially filled in the conduction band the electron can move freely thus these electrons are known as free electrons.

### 2.4.7: Forbidden gap/Energy gap $E_g$

The gap between the top of valance band and bottom of conduction band is called the energy band gap/Forbidden gap. No electron can exist in the forbidden gap. The energy gap may be large small or zero depending on the material.

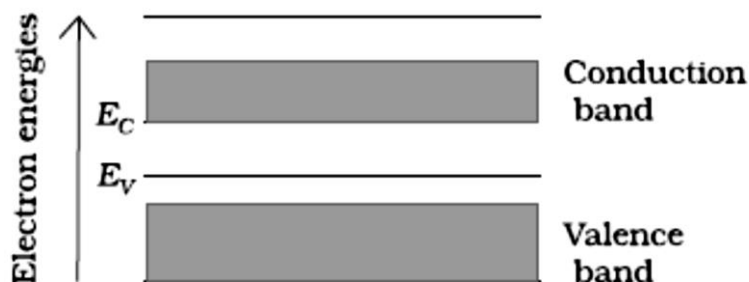

Fig. 2.4.7.1

### Case I Conductors.

The conduction band is partially filled and the valance band is partially empty or the conduction and valance band overlap. The energy gap is zero (0 eV). In overlap electrons from valance band

can move easily into the conduction band Thus we have electrons available for electrical conduction. The resistance of such materials is low or the conductivity is high.

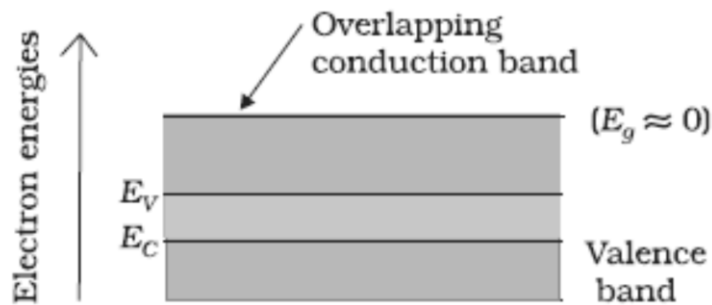

Fig. 2.4.7.2

**Case II Insulators:**

In this case a large band gap exists ( $E_g > 3eV$ ) There are no electrons in the conduction band and therefore no electrical conduction is possible the energy gap is so large that the electrons cannot be excited from valance band to conduction by thermal energy.

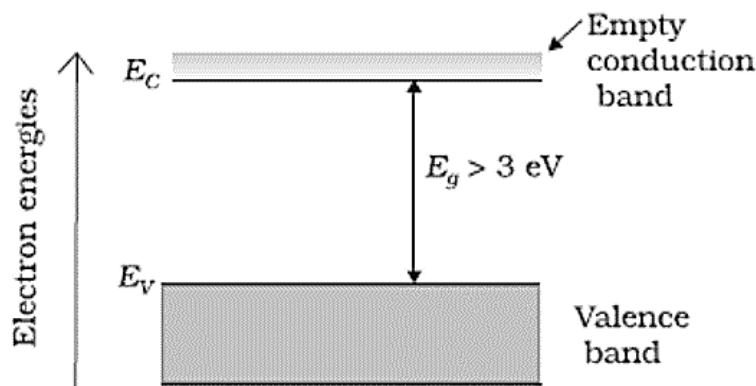

Fig. 2.4.7.3

**Case III Semiconductor:**

The energy band gap is finite & small ( $E_g < 3eV$ ) because of the small band gap of room temperatures some electrons from valance band can acquire enough energy to cross the energy gap and enter the conduction band. The resistance of semiconductor not as high as that of the insulator.

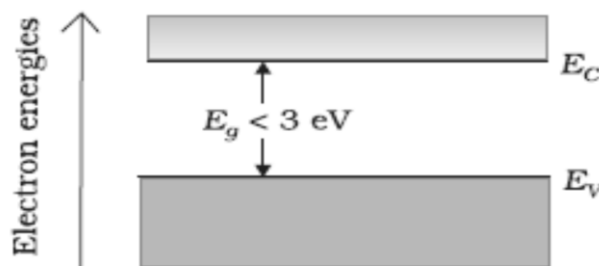

Fig 2.4.7.4

Semiconductor material that are mostly used are Germanium and Silicon. A Silicon and Germanium has atomic number 14 & 32 respectively. Thus the outer most shell has four electrons in outermost orbit. The atom is stable if there are 8 electrons in the outer most shell. Silicon & Germanium has ability to share four electrons.

#### 2.4.8: Semiconductor are of two type

1. Intrinsic Semiconductor
2. Extrinsic Semiconductor

##### 2.4.8.1: Intrinsic Semiconductor

A semiconductor in extremely pure form is known as intrinsic semiconductor. In Intrinsic Semiconductor Silicon and Germanium are surrounded by four neighboring atoms. The Silicon & Germanium atoms have four electrons in outermost orbit. The bond is formed by sharing of valance electron with other atom, such bonds are called as covalent bond. The valance electrons are not free thus the pure semiconductor are practically nonconductor of electricity at low temperatures. If thermal energy is provided to semiconductor the covalent band breaks to set the electron free. The electron detached from the atom becomes free to move in this the crystal. It is called free electron. The free electron leaves behind a vacancy with effective charge (+q). This vacancy with positive charge is called hole. The hole behaves as a free particle with effective positive charge.

One free electron produces one hole. Therefore, number of free electron is equal to number holes. The current is due to electrons as well as holes. When potential different is applied across the semiconductor free electrons are attracted to wards the positive terminals and holes forward negative terminal. The number of free electron and hole is small. Therefore, current is low or conductivity is low in intrinsic semiconductor.

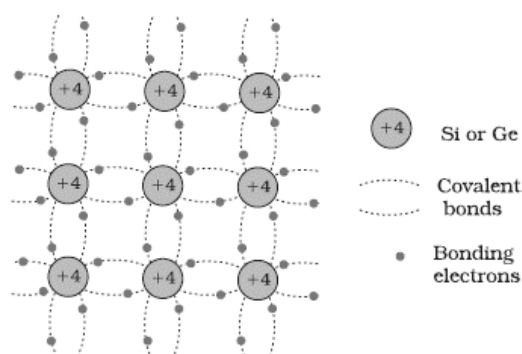

**Fig. 2.4.8.1**

##### 2.4.8.2: Extrinsic semiconductor

The conductivity of semiconductor is increased by adding a small amount of suitable impurity to pure semiconductor such materials are known as extrinsic semiconductor. The process of adding impurities to a semiconductor is known as doping and the impurity atoms are

called dopants. These materials are also called as doped semiconductor. There are two types of dopants used in doping the tetravalent silicon or germanium

- 1) Pentavalent (valency 5) like Arsenic, Antimony, Phosphorus etc.
- 2) Trivalent (Valence 3) like Indium, Boron, Aluminum. etc

### 2.4.8.3: N type semiconductor

A semiconductor in which number of free electron is much greater than hole, is called N type semiconductor.

When a small amount of pentavalent impurity is added to a pure semiconductor four bonds are formed with the silicon atom while the fifth electron remains weakly bound to its parent atom.

An atom like Arsenic or Antimony having five electron in outer most shell when added to Germanium or Silicon atom, the four electrons of Arsenic are shared by four electrons of Silicon to form covalent bond. The fifth electron of Arsenic remains free. Many free electrons are produced by addition of pentavalent impurity. These free electrons are available as electric current carriers. The pentavalent dopants are donating one extra electron for conduction and hence is known as donor impurity. The free electrons are majority carriers and holes are minority. At room temperature thermal energy generates few electron hole. The majority charge carrier are electrons which are negative charged hence semiconductors called N type semiconductor.

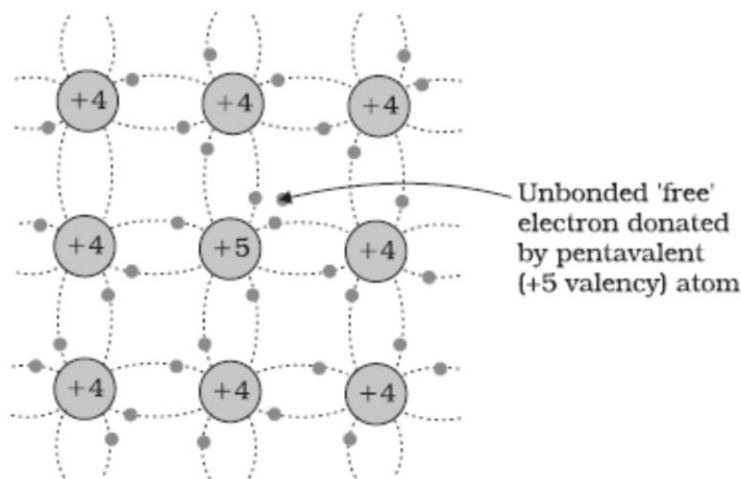

Fig. 2.4.8.1

### 2.4.8.4: P type semiconductor

A semiconductor in which number of holes is much greater than electron, it is called P type semiconductor. When a trivalent material is added to a pure semiconductor three covalent bonds are formed with the silicon atom. While a fourth bond is incomplete as it contains a hole.

An atom like Indium or Gallium having three valence electron is outer most shell when added to Germanium or Silicon atom, the three electron of Indium are shared by three electron of Silicon to form covalent bond fourth bond is incomplete and contains hole. Many holes are produced by addition of trivalent impurity. The trivalent impurity accepts electrons from surrounding atom hence it is known as acceptor impurity.



The majority charge carriers are holes which are positively charge and electrons re minority. At room temperature thermal energy generates few electron holes. The majority charge carriers are holes which are positively charged hence these semiconductors are called P types semiconductors.

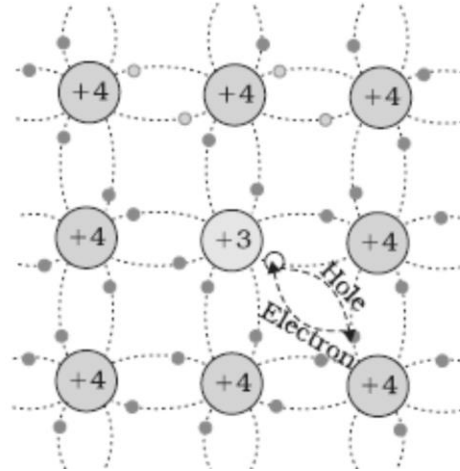

Fig. 2.4.8.4

## 2.5 :P-N junction

Two important process occur during formation of P-N junction diffusion current and drift current. In N type semiconductor the concentration of electron is more than concentration of holes. Similarly, in P type concentration of holes is more than concentration of electrons. During formation of P-N Junction concentration difference across the P sides and N sides, holes from P side diffuse into N side and electrons from N side diffuse into P side. This motion of charge carries gives rise to diffusion current across the junction.

When an electron diffuses from N side to P side it leaves behind an ionized donor on N side. The ionized donor which is positively charged and cannot move as it is bounded with surrounding atom. As electron continue to diffuse from N to P, a layer of positive charge is formed on N side of junction

Similarly, when hole diffuses form P side to N side due to concentration difference it leaves behind an ionized acceptor which is negativity charged it cannot move as it is bounded with surrounding atom. As holes continue to diffuse a layer of negative charge is formed on P side of junction

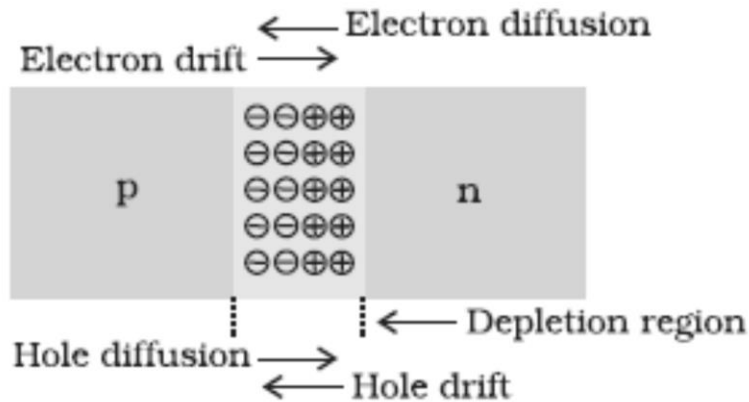

**Fig.2.5.1**

The motions of both majority carriers electrons and holes contribute to the buildup of space charge regions one positive and one negative these two regions form a depletion region or depletion layer. The positive space charge region on N side & negative space charge region on P side of junction. An electric field is directed from positive charge towards negative charge. The electron on P side of junction moves to N side and hole on N side of junction moves to P side due to the electric field. This motion of charges due to electric field is called drift current.

Thus drift current is opposite to diffusion current. Initially diffusion current is large and drift current is small. As the diffusion continues. The space charge regions on either side of junction extends, increasing the electric field strength, hence increases the drift current. This process continues till diffusion current equals drift current. Thus a P- N junction is formed, where no net current flows.

The loss of electrons from N region and gain of electron by P region causes a potential difference across the junction of two regions. This potential tends to prevent the movement of electron from N region into P region acting as a barrier, also called as barrier potential. The magnitude of barrier voltage at junction depends upon doping densities, electronic charge and junction temperature. The typical barrier voltages at room temperatures as 0.3 V for germanium and 0.7 V for silicon junction

**2.5.1: Semiconductor diode**

The semiconductor diode is basically a P-N junction with metallic contact provided at the ends for application of external voltage. The depletion region is 0.3 V and 0.7V for germanium and silicon, above this voltage current increases very rapidly with slight increase in forward voltage across the diode. In reverse bias connection conduction is very small, reverse saturation current flows through the diode.

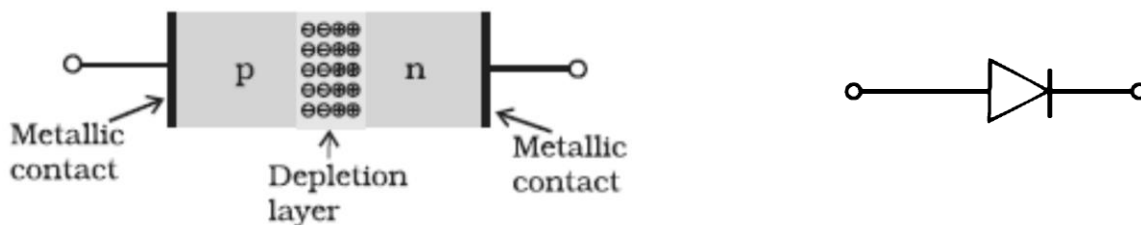

### 2.5.2: PN Junction Diode under forward bias

When an external voltage is applied across the semiconductor diode, such that positive terminal of battery is connected to P region and negative terminal of battery is connected to N region, the junction is said to be forward biased. The direction of applied voltage ( $V$ ) is opposite to the barrier potential ( $V_0$ ), as a result the depletion layer width decreases ( $V - V_0$ ). The +ve of battery pushes (repels) holes of 'P' side and holes cross the junction, similarly - ve of battery pushes (repels) electrons of 'N' side and electron crosses the junction. Thus majority charge carries cross the junction and reaches other end of battery, current flows through the junction

### 2.5.3: Forward bias connection of PN Junction diode

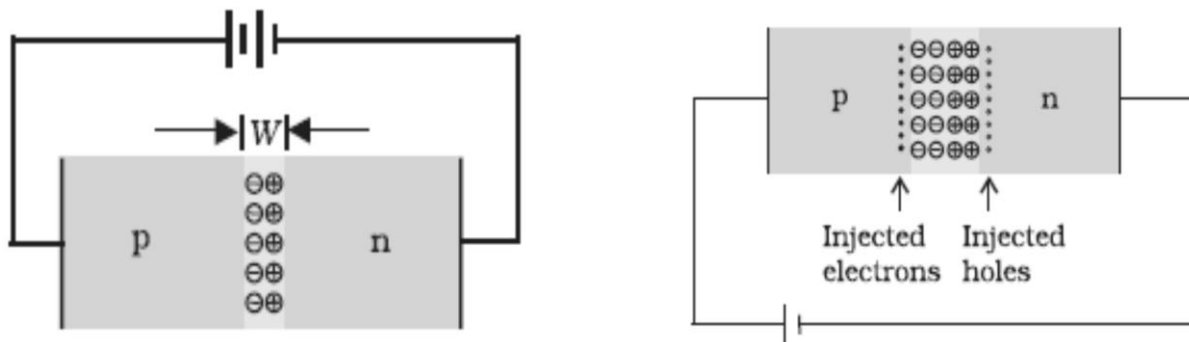

Fig. 2.5.3

### 2.5.4: PN junction diode under reverse bias

When an external voltage  $V$  is applied across the diode such that N side is connected to positive terminal of battery while the P side is connected to negative terminal of battery. It is said to be Reverse biased. The direction of applied voltage ( $V$ ) is same as the direction of potential barrier ( $V_0$ ) as a result depletion region width increases. ( $V + V_0$ )

The negative of battery pulls (attracts) holes of P side and holes move away from the junction. Similarly, the positive of battery pulls (attracts) electrons of N side and electrons move away from the junction. Thus majority charge moves away from the junction. Hence current does not flow in reverse bias.

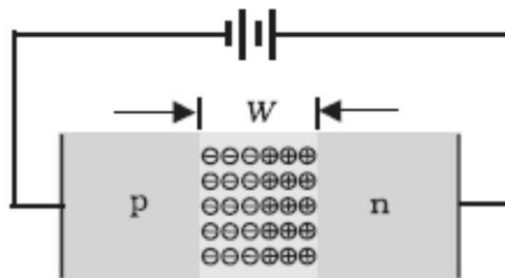

Fig. 2.5.4

### **2.5.5: I – V characteristics.**

#### **Forward biased – ( I quadrant)**

As  $V_{\text{ext}}$  is increased, corresponding current  $I_f$  values are recorded. The graph is plotted  $I_f$  on Y axis and  $V_{\text{ext}}$  on X axis (Variation of current as a function of voltage). It is observed that the current is negligible till the external voltage  $V_{\text{ext}}$  across the silicon diode crosses 0.7 V (barrier voltage). After 0.7 V as the external voltage is increased the current  $I_f$  increases sharply. This 0.7V in Silicon is called as threshold voltage or Cut in voltage. The current is measured in mA for forward bias.

#### **Reverse biased (III quadrant)**

$V_{\text{ext}}$  is increased and corresponding  $I_r$  values are recorded. The graph is plotted  $I_r$  on Y axis and  $V_{\text{ext}}$  on X axis (variation of current as a function of voltage). It is observed that the current is negligible and constant even though external voltage is increased. This is called reverse saturation current. However at high voltage i.e., at break down voltage the current suddenly increases. .

The PN junction diode primarily allows the flow of current only in one direction (forward bias) in forward bias the resistance is low as compared to reverse bias resistance

#### **Applications**

##### **Applications of electricity**

1. Electricity is used throughout the world to power devices, appliances and transportation
2. Electric trains have many components that use electricity, namely electric horn, electric motor
3. Electricity is used for computing, water heating, television, refrigeration, cooking and lighting
4. Building houses, installing gates and windows, welding of material require current electricity to operate the machine
5. Street lights, lawn mower, water sprinkler are some uses of electricity in outdoor.
6. Giant magnets require electricity to keep it charged for lifting heavy metals.
7. The lights, lifts, AC, coffee machine, ID Card reader, biometric scanner in office requires electricity.
8. The satellite and probes that are sent from the earth for space expeditions run on electricity
9. Surgical operations in operation theater requires powerful lights.
10. All the entertainment gadgets such as MP3 player, DVD, VCRS or VCRS run on electricity.

##### **Applications of magnetism**

1. Electromagnets are widely used as components of electrical devices such as motors, generators, relays, solenoids, loudspeakers, hard disks, MRI machines, scientific instruments and magnetic separation instruments.
2. Mines use magnetic sorting machines to separate useful metallic ores from crushed rock
3. In food processing, magnets remove small metal bits from food grains
4. Common uses of magnets include compass, vending machine, refrigerator magnets and electric motors.
5. Mass spectrometer use electric or magnetic fields to identify different materials.

6. Faradays law of electromagnetic induction is the basis of many devices such as electric motors, generators, giant cranes, auto ignition in cars, and alignment of microscopic magnetic particles on computer hard disk drive.
7. Maglevs are the fastest trains systems in the world. They use the basic principles of attraction and repulsion in magnetism.
8. MRI (magnetic resonance Imaging) system in medicine uses a combination of a magnetic field and electromagnetic waves to generate image of parts of human body.
9. Magnetometers are used by astronomers to detect the strength and direction of magnetic field surrounding Earth and other bodies in space.

### **Applications of current electricity**

1. Ohm's law helps to determine voltage, current or resistance/ impedance of a linear electric circuit when any of two quantities are known.
2. Ohm's law makes power calculations simpler.
3. Parallel circuit is used in wiring system of a house.
4. Batteries are connected in series circuit to increase the output voltage/ power.
5. All mains operated instruments have switches connected in series. It controls the operation of device.
6. Freezer, refrigerator, water pump, water, heater, fuse, are the examples of series circuit.
7. Car headlights, wiring of speaker system in professional venues, streetlamps, house lighting, computer address and data buses, alarm systems, electrical subscribers connected to transformers are connected in parallel.
8. The heating effect of electric current is used in electrical appliances like electric heater, electric iron, electric room heater, immersion heater, electric kettle, hair dryer etc.

### **Applications of Semiconductors**

1. NP junction diodes are commonly used for rectification (where AC is converted into DC)
2. Used as clipper for clipping AC portion
3. Used as clamper i.e. to change reference voltage
4. Used as switches in most electronic circuits.
5. Used as switches in digital logic circuits
6. Used in demodulator circuit
7. Used in detector circuit
8. Used in voltage multipliers

### **E-learning websites.**

1. *Phet. Colovado. Edu*
2. *www.examfear.com*
3. *Ocw.mit.edu*
4. *www.khanacademy.org*
5. *Amrita virtual labs. Vlab.amrita.edu*

**Sample MCQs**

1. The direction of magnetic field within a magnet is \_\_\_\_\_
  - a) From south to north
  - b) From north to south
  - c) Back to front
  - d) Front to backAns: (a)
2. If bar magnet is broken into two pieces the pole strength of each half will be \_\_\_\_\_
  - a)  $\frac{1}{2}$ , b) Same, c)  $\frac{1}{4}$ , d) doubleAns: (b)
3. SI unit of resistivity is
  - a) Ohm/inch b) Ohm/foot c) Ohm-m d) Ohm-cm.Ans:(c)
4. Electric field intensity is in \_\_\_\_\_
  - a) Volt/meter b) Newton/meter
  - c) Newton-meter d) Ampere / meterAns:(b)
5. In series combination current passing through each resistor is \_\_\_\_\_
  - a) different b) same c) Zero d) high.Ans:(b)
6. In case of semiconductors, the band gap energy is-----
  - a) Equal to 3 eV
  - b) More than 3 eV
  - c) Less than 3 eV
  - d) Varying and more than 3 eVAns (c)
7. In p type semiconductor -----
  - a) electron are majority charge carriers
  - b) holes are majority
  - c) holes are minority charge carriers
  - d) holes & e<sup>-</sup> carries are in equal amountAns:(b)
8. When PN junction diode is connected in forward biased condition, then the width of depletion layer -----
  - a) Remain same
  - b) Increases & these decreases
  - c) Increases
  - d) DecreasesAns:(d)
9. ----- of the following is not an application of PN junction diode .
  - a) Used as filter
  - b) Used in rectifier
  - c) Used as clamper
  - d) Used as clipperAns:(a)
10. ----- of the following is a semiconductor material?
  - a) Aluminum
  - b) Carbon

- c) Ebonite
- d) Germanium

Ans:(d)

**Reference:**

- 1) Engineering physics R.K.Gaur, S.L.Gupta Dhanpat Rai Publications
- 2) Text book of physics for class XI & XII (Part-I, Part – II) NCERT New Delhi
- 3) Physics standart XI Shri vivek uttam Gosavi Controller Maharashtra state  
Texbook Bwceau, Mumbai.

**Self-directed learning**

- 1) Collect information on following devices Electric bulb, Electric fuse, Electric iron, solenoid
  - 2) Study Earth's magnetic field
- a) C, Si, Ge have same lattice structure. Why is C insulator while Si and Ge intrinsic semiconductor?
  - b) Can we take one slab of p type semiconductor and physically join it to an after n type semiconductor to get P-N junction?
  - c) Can diodes work as switch?

**Suggestion for micro project**

- a) Hand battery
- b) Magnetic atmosphere on magnetic field strength
- c) Effect of temperature on magnetic field strength
- d) Types of magnets.
- e) Comparison of electrostatics and magnetism
- f) Locate direction of magnetic field using bar magnet.
- g) Compare resistivity of different metals.
- h) Identify types of diodes
- i) List uses of different diodes
- j) Difference between diodes4 resistors
- k) Use of diodes in your core branches

## Unit 3

### Heat and Optics

**Course outcome:** Use the basic principles of heat and optics in related engineering applications.

#### Unit outcomes

- 3a) Convert the given temperature in different temperature scales.
- 3b) Describe the properties of the given good and bad conductors of heat
- 3c) Relate characteristics of the three gas laws
- 3d) Determine the relation between specific heats for the given materials
- 3e) Distinguish the phenomena of total reflection for the given medium
- 3f) Describe light propagation in the given type of optical fiber

#### Introduction/ Rationale

Concept of heat plays key role in engineering field. Such as material section, machine efficiency and kinetics. In this lesson, students learn the scientific concept of temperature, heat and heat transfer through conduction, convection and radiation. Also bad and good conducting materials and their industrial applications will be studied. Gas laws are explained to understand the relation between pressure, volume and temperature. The concept of specific heat indicates; how much energy will be required to heat or cool an object of a given mass by a given amount. In the following lesson students will learn the concept of total internal reflection as well as the principle of optical fiber. Light is a form of energy which travels in the form of electromagnetic waves. Visible light has wavelength range of  $4000 \text{ \AA}^0$  to  $7500 \text{ \AA}^0$ . Light travels in a straight line with a speed of  $3 \times 10^8 \text{ m/s}$ . The path of light is termed as ray of light.

#### Significance

Various machines or devices make use of good conductors of heat such as copper, aluminum, brass and bad conductors of heat such as glass ceramic rubber. These metals work on the modes of heat transfer. Gas laws are useful in engineering, medical field as well as in everyday life. Practical applications of optics are found in a variety of technologies and everyday objects including mirrors, lenses, telescopes, microscopes, lasers and fiber optics.

#### 3.1 Heat and temperature

##### 3.1.1: Heat

During summer we feel hot. It is due to the transfer of heat from Sun to us.

Heat is an energy.

Definition of heat: - heat is an energy which produces sensation of hotness or warmness.

Units of heat: -

S.I. Unit is joule (J)

MKS unit is kilocalorie (kcal)



CGS unit is calorie (cal)

One calorie:

The amount of heat energy required to increase the temperature of one gram of water through 1<sup>o</sup> C is called as One calorie.

One kilocalorie:

The amount of heat energy required to increase the temperature of one kilogram of water through 1<sup>o</sup> C is called as One kilocalorie.

One joule:

The amount of heat energy required to increase the temperature of  $\frac{1}{4.186}$  gram of water through 1<sup>o</sup> C is called as One joule.

### 3.1.2: Temperature

As heat is a cause, temperature is its effect.

Definition of Temperature: - “The temperature is the measure of degree of hotness or coldness of a body.”

Temperature is measured using thermometer. SI unit of temperature is °k (degree kelvin)

If heat is supplied to a body, its temperature increases and if heat is removed from a body its temperature decreases.

Temperature is the measure of average K.E. of particles of a body.

### 3.1.3: Difference between heat and temperature

**Table 3.1**

Heat	Temperature
1. Heat is an energy which produces sensation of hotness.	1. Temperature is a measure of degree of hotness or coldness of a body.
2. Heat is the sum of energies of all molecules in the body.	2. It is the average K.E of the molecules of the body.
3. Heat flows from higher temperature to lower temperature.	3. Temperature determines the direction of flow of heat.
4. Heat is an extensive property.	4. Temperature is an intensive property.
5. Heat is a cause.	5. Temperature is the effect.
6. SI unit is joule ( j)	6. SI unit is kelvin (k)

### 3.1.4: Temperature Scales

Following three scales are commonly used -

Celsius scale of temperature – This scale was given by sanders Celsius in 1742

1. In this scale lower fixed point is considered as 0<sup>o</sup>c melting point of ice and upper fixed point as 100<sup>o</sup>c (B.P of water) then it is divided into 100 equal parts. Each part is called as one degree Celsius (1<sup>o</sup>c)

This scale was suggested by German physicist Fahrenheit in 172<sup>o</sup> c, °K, °F)

2. Fahrenheit scale of temperature: - In this scale lower fixed point is 32<sup>o</sup> F upper 212<sup>o</sup> F this interval is divided into 180 equal parts. Each part is called degree Fahrenheit.

3. Kelvin scale or absolute scale of temperature- in this scale the lower fixed point is 273 k and upper fixed point is 373 k. then it is divided into 100 equal parts, each part is called as one-degree Kelvin ( $1^{\circ}\text{K}$ )

### 3.1.5: Relation between $^{\circ}\text{K}$ , $^{\circ}\text{C}$ , $^{\circ}\text{F}$

$$C = \frac{F-32}{1.8} = K-273$$

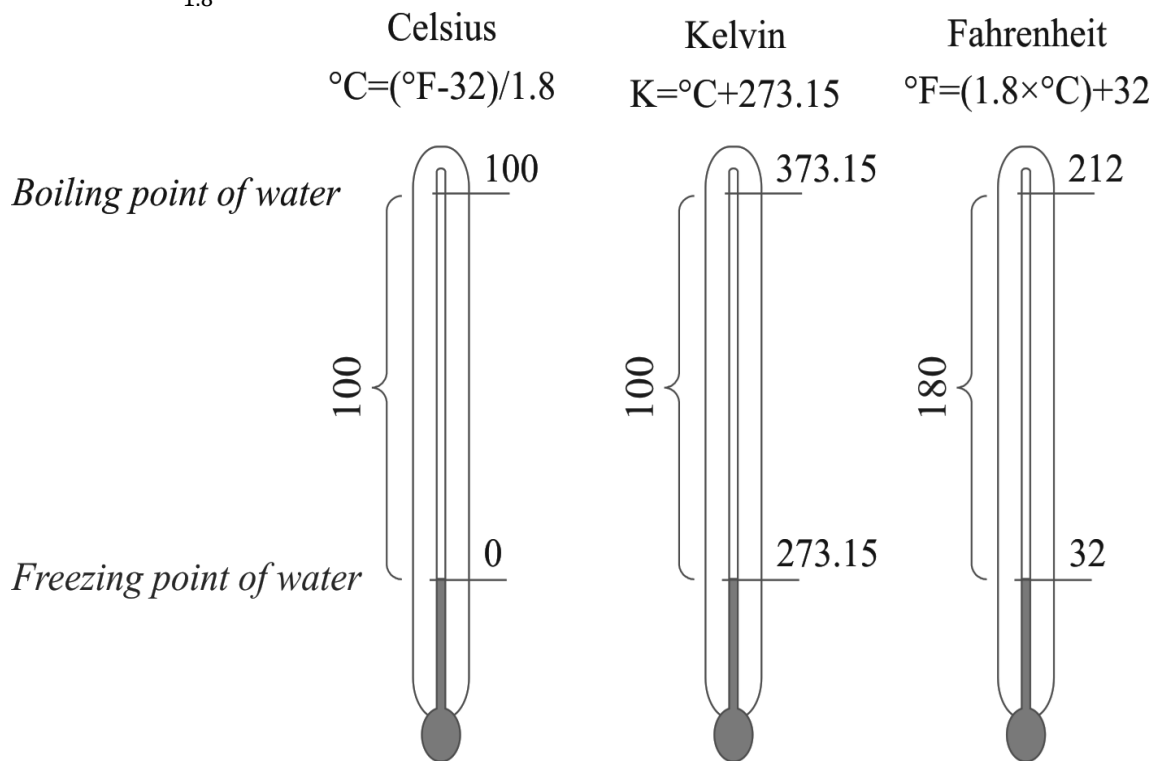

**Fig 3.1.5**

Absolute zero :-

According to Charles law and Gay- Lussacs law if temperature heat is supplied to gases i.e. it temperature increased then its pressure and volume also increases on the other hand, if we go on Cooling a gas then its pressure and volume decreases. It is observed that at  $-273^{\circ}\text{C}$  pressure and volume of a gas theoretically becomes zero.

**Definition: -**

“The temperature at which pressure and volume of a gas theoretically becomes zero is called as absolute zero temperature”

Practically it is not possible, because much before this temp ( $-273^{\circ}\text{C}$ ) the gas liquifies and then solidities.

**NTP: -** it is the normal temperature and pressure. At sea level the temp is  $0^{\circ}\text{C}$  or  $273^{\circ}\text{K}$  and pressure is 76 cm of mercury

### 3.2 Modes of transfer of heat

consider a metal rod AB. If heat is supplied to its one end, it is observed that other end also gets heated.

Heat always transferred from a part at higher temperature to a part which is at lower temperature.

This transfer of heat takes place in three different ways

1. conduction
2. convection
3. radiation

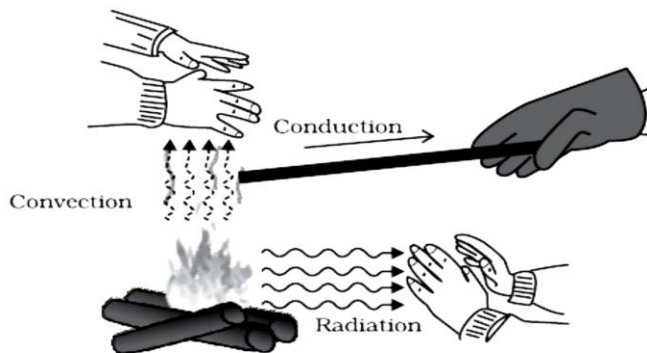

**Fig: 3.2**

**3.2.1: Conduction:** - Consider a metal rod AB one end of it is placed on a flame as shown in fig 3.2.1

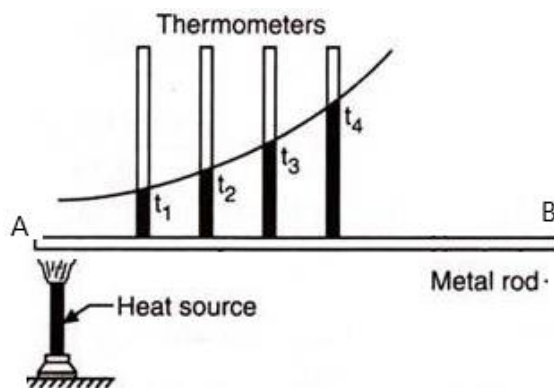

**Fig:3.2.1**

After some time, the other end of the rod gets heated. Heat transfers from A towards B. Here heat transfer takes place through molecules. On receiving heat, molecules at end A start vibrating and collide with its neighboring molecule and transfer heat.

Conduction: - “It is a process of transfer of heat from a part of body at higher temperature to part of body at lower temperature without actual movement of particles”.

**3.2.2: Convection:** -

Consider some water in a container. Supply heat to this container as shown in figure below.

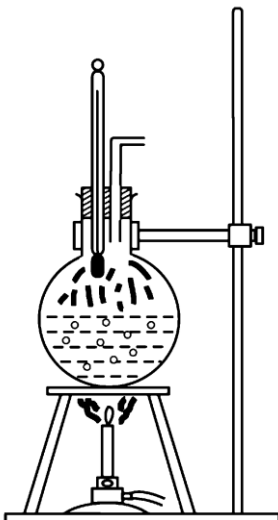

**Fig 3.2.2**

On receiving heat, the molecules at the base of the container becomes light in weight. And moves upward. Now the new colder molecules come to the bottom of the container in this process heat gets transferred continuously throughout the water, by moving molecules.

It is the process of transfer of heat from part of a body at higher temperature to part of a body at lower temperature with actual movement of particles.

**3.2.3: Radiation:** - It is the process of transfer of heat in the form of electromagnetic waves, from a body at higher temperature to a body at lower temperature without necessity of the intervening medium.

When we stand near an open fire we feel warm. Here the heat gets transferred by thermal radiation

“Radiation is the process of heat transfer of heat from one body to another without necessity of the medium.

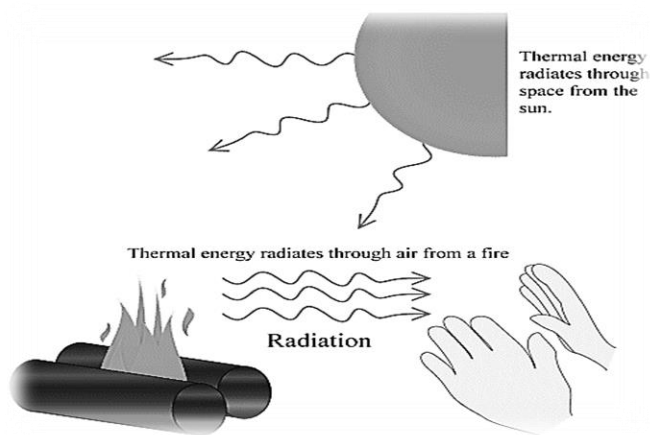

**Fig:3.2.3**

We receive heat energy from sun by the way of Radiation.

Table 3.2

Good conductor	Bad conductor
<ol style="list-style-type: none"> <li>1. The materials through which heat conducts easily and immediately are called good conductors.</li> <li>2. Value of K is high.</li> <li>3. Value of R is low</li> <li>4. e.g. Al , Cu, all metals</li> </ol>	<ol style="list-style-type: none"> <li>1. The materials through which heat is not conducted easily are called as bad conductors.</li> <li>2. value of K is low.</li> <li>3. value of R is high</li> <li>4. e.g. glass, Plastic, Wool etc.</li> </ol>

K – coefficient of thermal conductivity

R- thermal resistance bad conductors are also called as insulators

### 3.2.3: Applications of Good conductor & bad conductors of heat

1. Good conducting material is used in electronic circuits to protect costly component from overheating.
2. Bad conductors of heat such as glass, coal, thermocole, saw dust are used as insulating materials to maintain low temperature.
3. In an electric heater, spiral coil of good conductor is used so that heat developed is conducted to liquid in contact quickly
4. Condenser coil in a refrigerator is made up of good conductor (copper)
5. A bad conducting material like thermocole is used in ice box. Due to this ice melts very slowly.
6. Handle of cooker is made up of bad conducting material like plastic, so that handle can be hold easily.
7. Thermos flask contains double walled glass vessel with vacuum between the walls. As conduction cannot take place in vacuum and glass is a bad conductor of heat, so liquid in thermos flask remains hot for longer time.

### 3.2.4: Applications of conduction

1. When a car is turned on, the engine of a car becomes hot even the hood will become warms as heat is conducted from engine to the hood.
2. Cooking utensils, saucepans, kettles and boilers are made of metals use direct heat energy for conduction
3. Soldering iron is made of iron with a copper tip because copper is good conductor of heat
4. Handles of kettles and spoons are made of plastic or wood because wood is the bad conductor of heat in this way, the hot kettles utensils and spoons can be picked up without burning our hands.
5. Woolen clothes or blankets give warmness in cold weather.
6. Sawdust has good insulating property so it acts as a bad conductor when covered up the ice blocks
7. Heat sinks are used to cover the electronic components.

8. Heat exchangers are widely used in refrigeration air conditioning, space heating, power generation and chemical processing
9. Car radiator uses hot coolant fluid cooled by the flow of air over the surface of radiator

### 3.2.5: Application of Convection

- 1) Room ventilation: Ventilators (exhaust fans) are fitted at high positive in the room.
- 2) Electric fans.
- 3) Refrigerators.
- 4) Air conditioner.
- 5) Formation of trade winds.
- 6) Formation of sea breeze & land breeze.
- 7) Gas filled coiled electric lamps.
- 8) Cooling system in automobile engines.

### 3.2.6: Application of Radiation-

- 1) Thermal radiator- Electric bulb, The sun.
- 2) White or light coloured clothes absorb less heat, so they are preferred in summer
- 3) The teapots and kettle have shining surface.
- 4) Heat radiators in cars, machines are painted black which radiate heat & maintain cool.
- 5) Base of cooking utensils is made black, which is a good absorber and cook Food easily.
- 6) Aeroplanes and ships are painted white to minimize absorption of heat.
- 7) High absorbing power of water vapour is a natural gift which protects us form high temperature.
- 8) The polished surface of space craft reflects most of the heat.
- 9) Hot water pipes are painted back colour.

### 3.2.7: Law of thermal conductivity and coefficient of thermal conductivity

Consider a rod AB of metal. This rod is in steady state of temperature. ie. no heat is lost to the surroundings by convective and radiation.

ie. Heat absorbed = Heat given out

Consider two points C and D in the metal rod, as shown in the fig 3.2.6

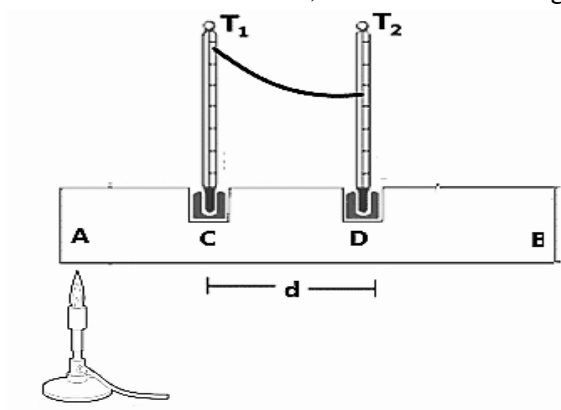

Fig :3.2.7

Let,

A-cross sectional area of rod

Q-the amount of heat flowing form C to D

d- distance between C and D

$\Theta_1$ -temperature of plane C in thermometer  $T_1$

$\Theta_2$  - temperature of plane D in thermometer  $T_2$

Here  $\Theta_1 > \Theta_2$

The amount of heath conducted through the in steady state is directly proportional to

- 1) cross sectional area a
- 2) temperature difference between layers C and D i.e.  $\Theta_1 - \Theta_2$
- 3) time for which heat flows i.e. T and inversely proportional to
- 4) distance d between two planes C & D

$$Q \propto A$$

$$Q \propto (\Theta_1 - \Theta_2)$$

$$Q \propto t$$

$$Q \propto 1/d$$

Combining above we can write

$$Q \propto \frac{A(\Theta_1 - \Theta_2)t}{d}$$

$$Q = \text{constant} \times \frac{A \times (\Theta_1 - \Theta_2) \times t}{d}$$

$$Q = K \times \frac{A \times (\Theta_1 - \Theta_2) \times t}{d}$$

Where K is coefficient of thermal conducting.

Form above equations we get

$$K = \frac{Q \cdot d}{A(\Theta_1 - \Theta_2)t}$$

If,  $d=1$ ,  $A=1$ ,  $(\Theta_1 - \Theta_2)=1$ ,  $t=1$  then  $K=Q$

### 3.2.7: Definitions of coefficient of thermal conductivity-

It is defined as the amount of heat conducted in steady of temp of the rod per unit time, per unit cross-sectional area, for unit temperature gradient

Here  $\frac{\Theta_1 - \Theta_2}{d}$  is called as the temperature gradient.

Temp gradient is the change in temperature per unit length of the rod.

Unit of temperature gradient is  $^{\circ}\text{C}/\text{m}$  or  $^{\circ}\text{K}/\text{m}$

**Example:**

A windows pane with glass material has a dimension 100cm x 50cm x 5mm. Amount of heat conducted in one hour is Q. calculate Q if the temperature difference is 5<sup>0</sup>C between outside & inside. given k for glass =1 W/m/<sup>0</sup>K

Given       $A = 100 \text{ cm} \times 50 \text{ cm}$   
 $= 1 \text{ m} \times 0.5 \text{ m} = 0.5 \text{ m}^2$   
 $d = 5 \text{ mm} = 5 \times 10^{-3} \text{ m}$   
 $t = 1 \text{ hr} = 60 \times 60 = 3600 \text{ sec}$   
 $\Theta_1 - \Theta_2 = 5^0 \text{ c}$   
 $k = 1 \text{ w/m / } ^0 \text{ k}$

Formula:     $Q = k \frac{A (\Theta_1 - \Theta_2) t}{d}$   
 $= \frac{1 \times 0.5 \times 5 \times 3600}{5 \times 10^{-3}}$   
 $= 18 \times 10^5 \text{ J}$

**3.3 : Gas laws****3.3.1: Boyle's law**

This law gives the relation between pressure and volume of constant temperature.

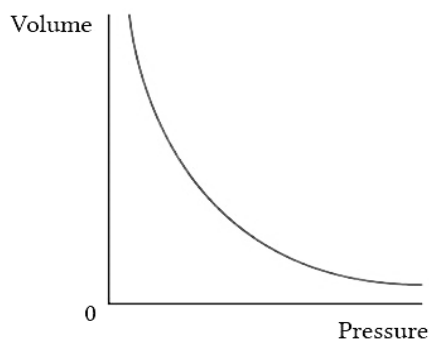
**Boyle's Law****Fig:3.3.1****Statement of Boyle's law**

“For fixed mass of a gas temperature of a gas remaining Constant its pressure is inversely proportional to volume”

i.e     $P \propto \frac{1}{V}$  (at const. temp)

$$P = \text{const} , \propto \frac{1}{V}$$

$$PV = \text{const.}$$

$$P_1 V_1 = P_2 V_2 = \text{const}$$

Where  $P_1, P_2$  are pressure &  $V_1, V_2$  are volumes at constant temperature of fixed mass of gas.



### 3.3.2: Charle’s law

This law gives relation between volume & temperature at constant pressure.

#### Charles’ Law

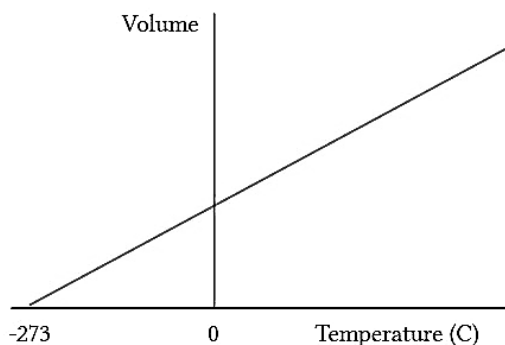

**Fig: 3.3.2**

Statement of Charle’s **law**:

“For fixed mass of a gas, if pressure of a gas is kept constant then its volume is directly proportional to absolute temperature”

i.e  $V \propto T$  -----( at constant pressure)

$$\frac{V}{T} = \text{constant}$$

$$\frac{V_1}{T_1} = \frac{V_2}{T_2} = \text{constant}$$

Where  $V_1, V_2$  are volumes and  $T_1, T_2$  are temperatures of given mass of gas.

### 3.3.3: Gay lussac’s law

This law gives the relation between pressure and temperature at constant volume of gas.

#### Gay Lussac’s Law

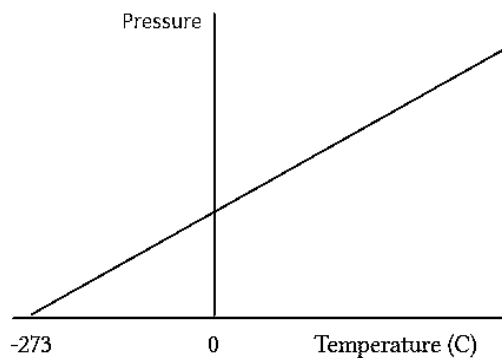

**Fig:3.3.3**

**Statement of Gay Lussacç law:**

“For fixed mass of a gas if volume is kept constant, then its pressure is directly proportional to absolute temperature.”

i.e  $P \propto T$  (at constant volume )

$$\frac{P}{T} = \text{constant,}$$

$$\frac{P_1}{T_1} = \frac{P_2}{T_2} = \text{const}$$

Where  $P_1, P_2$  are pressure &  $T_1, T_2$  are temperature of given mass of gas.

**3.3.4: General Gas Equation/Perfect Gas Equation**

The relation between pressure, volume and temperature is given by gas laws. Each law gives the relations of two variables by keeping third variable constant.

The relation between all the three variables is given by Perfect Gas Equation.

According to Gay- Lussac’s Law

$$P \propto T$$

And according to Charles law

$$V \propto T$$

Combining above two equations we get,

$$P \times V \propto T$$

$$P \times V = \text{Const.} \times T$$

$$PV = KT \text{ -----(1)}$$

Where,

$K$  = Specific gas constant. (constant  $K$  is different for different gases) This constant depends on mass and nature of gas.

Equation- 1 is known as ideal gas equation.

If mass of gas is 1 kg-mole OR 1 gm-mole then proportionality constant  $K$  will have same value for all gases. Therefore,  $k$  is replaced by  $R$

**3.3.5: Perfect Gas Equation**

From above two equations we can write

$$PV \propto T$$

$$PV = \text{constant} \times T$$

$$PV = KT$$

Where  $K$  is constant called as specific gas constant, value of  $K$  is different for different gases, since it depends on mass and nature of gas.

If we consider molecular weight of gas (gram-mole or kg. mole) then constant  $K$  will have same value for all gases. Replacing  $K$  by another constant  $R$ , we get

$$PV = RT$$

This is called General gas equation

OR

Perfect gas equation OR Universal gas equation

Where R- universal gas constant,

Value of R is same for all gases, because one-gram mole of any gas occupies same volume under NTP. ( P = 76 cm of mercury, T= 273°K)

R= 8314.91J/°k.kg mole or R=8.314 J/mole°k

Examples:-

1) The volume of a gas at 20 °C is 500 cm<sup>3</sup> .What will be its volume at 80 °C.

Solution :-

Given :-

$$T_1 = 20+273= 293 \text{ }^0\text{K}$$

$$V_1 = 500 \text{ cm}^3$$

$$T_2 = 80+273 = 353 \text{ }^0\text{K}$$

$$V_2 = ?$$

Formula :-

$$\begin{aligned} \frac{V_1}{T_1} &= \frac{V_2}{T_2} \\ V_2 &= \frac{V_1 T_2}{T_1} \\ &= \frac{500 \times 353}{293} \\ &= 602.39 \text{ cm}^3 \end{aligned}$$

2) A gas at 20 °C and pressure of 70 cm. of mercury has volume 2.5 litres. Find its volume at 30 °C and pressure of 85cm of mercury.

Solution:-

Given:-

$$T_1 = 20 + 273 = 293 \text{ }^0\text{K}$$

$$P_1 = 70 \text{ cm}$$

$$V_1 = 2.5 \text{ Litre}$$

$$T_2 = 30 + 273 = 303 \text{ }^0\text{k}$$

$$P_2 = 85 \text{ cm}$$

$$V_2 = ?$$

$$\begin{aligned} \text{Formula:- } \frac{P_1 V_1}{T_1} &= \frac{P_2 V_2}{T_2} \\ \therefore \frac{70 \times 2.5}{293} &= \frac{85 \times v_2}{303} \\ V_2 &= 2.12 \text{ Lit.} \end{aligned}$$

### 3.3.6: Application of gas laws

**Boyle's law**

- 1) Spray paint
- 2) Soda can
- 3) The syringe

**Charles law**

- 1) Helium ballon
- 2) Hot air bollon
- 3) Deodorant spray bottle
- 4) Type pressure- low in winter (cold)

**Gay Lussacs**

- 1) Firing a bullet
- 2) Heating a closed a aerosol can-may cause the container to explode.

**3.4 Heat capacity (s)**

The change in temperature of substance, when a given quantity of heat is absorbed or rejected by it, is characterized by a quantity called ‘heat capacity’ of a substance

Heat capacity (s) of substance is given by

$$S = \frac{Q}{t} \dots\dots\dots (i)$$

∴ Q= amount of heat supplied to the substance to change its temperature by t.

If equal amount of heat is added to equal masses of different substances, the resulting temperature changes will not be same i.e each substance has a unique value for the amount of heat absorbed or rejected to change the unit mass of it by a unit. This refers to the specific heat capacity of the substance it is given by

$$S = \frac{s}{m} = \frac{1}{m} \times \frac{\Delta Q}{\Delta t} \dots\dots\dots(ii)$$

**3.4.1 Specific heat of gases**

The specific heat of a substance is defined as the amount of heat required to increase the temperature of unit mass of the substance through 1°c.

The specific heat capacity is the property of substance which determines the change in the temperature of substance when a given quantity of heat is absorbed or rejected by it.

Specific heat capacity “s” is defined as the amount of heat per unit mass absorbed or rejected by the substance to change its temperature by one unit. It depends on nature of substance and its temperature.

SI unit of specific heat capacity is J/kg°k

If amount of substance is specified in terms of mole ‘μ’ instead of mass ‘m’ kg then the molar specific heat capacity ‘c’ is given by

$$C = \frac{s}{\mu} = \frac{1}{\mu} \times \frac{Q}{t} \dots\dots\dots (iii)$$

SI unit of molar heat capacity is J/mol°k

When we heat a substance it increases in volume. Thus surrounding atmosphere increases through a small distance. As a result of this external mechanical work is done against the atmospheric pressure.

In case of solids and liquids the change in volume is very small hence the external mechanical work done while changing the temperature is very less. But, in case of gases, there is

a large change in volume and pressure and part of this work is utilized to do the external mechanical work.

In case of solids and liquids heating takes place at constant pressure while in case of gases heating can be done either at constant pressure or at constant volume. Therefore gas has two specific heats, namely

- i) Specific heat at constant volume ( $C_v$ )
- ii) Specific hat at constant pressure ( $C_p$ )

These two specific heats are called principle specific heats of gases.

### 3.4.2 Specific heat of gas at constant volume ( $C_v$ )

The amount of heat required to raise the temperature of unit mass of gas through  $1^\circ\text{C}$  when its volume is kept constant is called specific heat of the gas at constant volume and denoted by  $c_v$ .

If we heat 'm' gram of gas enclosed in a cylinder fitted with a piston, the volume of the gas will not increase but only pressure and temperature will increase. As there is no increase in volume there will be no external work done and total heat energy supplied will be used to increase the temperature of the gas.

Let the initial temperature of gas be  $\Theta_1$  and final temperature at constant volume be  $\Theta_2$ , then the heat supplied to the 'm' gm of the gas.

$Q_1 = \text{mass} \times \text{specific heat at constant volume} \times \text{rise in temperature.}$

$$\therefore Q_1 = m \times c_v (\Theta_2 - \Theta_1)$$

$$\therefore Q_1 = m c_v dT$$

$\therefore dT = \text{change in temperature.}$

### 3.4.3 Specific heat of a gas at constant pressure ( $C_p$ )

The amount of heat required to increase the temperature of unit mass of a gas through  $10^\circ\text{C}$  when its pressure is kept constant is called specific heat at constant pressure denoted as  $C_p$ .

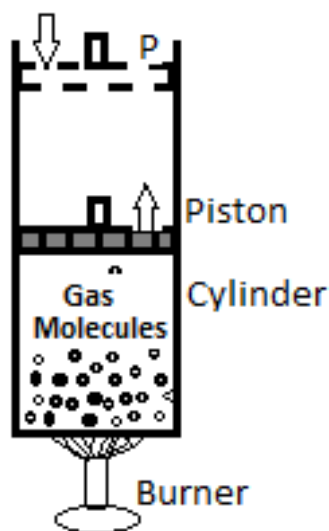

**Fig. 3.4.3 Heating of a gas at constant pressure.**

Consider a cylinder fitted with piston of negligible mass and friction as shown in fig 3.4.3. Fill the cylinder with ‘m’ gram of gas and start heating. The temperature of the gas increases with increase in volume of gas. Piston moves upward keeping pressure constant, equal to atmospheric pressure. As a volume is increased some external work is done and the heat energy supplied gets utilized in two ways,

- i) Increase the temperature of gas. This is equal to  $mc_v (\Theta_2 - \Theta_1)$
- ii) Fording work by increasing the volume of gas.

As during heating the gas at constant pressure, extra work is done therefore  $c_p$  is greater than  $c_v$

### 3.4.4 Work done at constant pressure

Work done by heating the gas at constant pressure is given by,

$$W = R(T_2 - T_1)$$

∴  $W =$  work done

$R =$  universal gas constant

$T_2 - T_1 = \Theta_2 - \Theta_1 =$  change in temperature of the gas at expansion.

S-I unit of work done is joule

Gas unit of work done is erg.

$$1J = 10^7 \text{ erg.}$$

### 3.4.5: Relation between $C_p$ and $C_v$ (Mayor’s relation)

$$C_p - C_v = \frac{R}{J}$$

∴  $C_p =$  specific heat of gas at constant pressure.

$C_v =$  specific heat of gas at constant volume

$R =$  universal gas constant.

$J =$  mechanical equivalent of heat.

### 3.4.6 Ratio of two specific heats ( $\gamma$ )

The ratio of  $C_p$  and  $C_v$  is denoted by ‘ $\gamma$ ’. It is also known as adiabatic index.

$$\gamma = \frac{c_p}{c_v}$$

As  $C_p > C_v$ ,  $\gamma > 1$

$\gamma = 1.66$  for monoatomic gas

$\Gamma = 1.4$  for diatomic gas (air)

### Example

The ratio of two specific heats of a gas is 1.4 and the difference is 0.0808. Find values of  $c_p$  and  $c_v$

Given:-  $\frac{C_p}{C_v} = 1.4$

$$C_p - C_v = 0.0808$$

$$\therefore C_p = 1.4 \times C_v \dots\dots\dots ( I )$$

$$\therefore C_p - C_v = 0.0808$$

$$\therefore 1.4C_v - C_v = 0.0808$$

$$\therefore 0.4 c_v = 0.0808$$

$$\therefore C_v = \frac{0.0808}{0.4} = 0.202 \text{ unit}$$

$$\therefore C_p = 1.4 \times 0.202$$

$$\therefore C_p = 0.2828 \text{ unit}$$

### 3.5: Optics

#### 3.5.1: Reflection of light-

When light reaches reflecting media then it bounces (rebounds) back in the same media.

Let,

PQ=incident ray

QR=reflected ray

NN'=normal to reflecting media

$\angle i$  = angel of incidence

$\angle r$  = angle of reflection

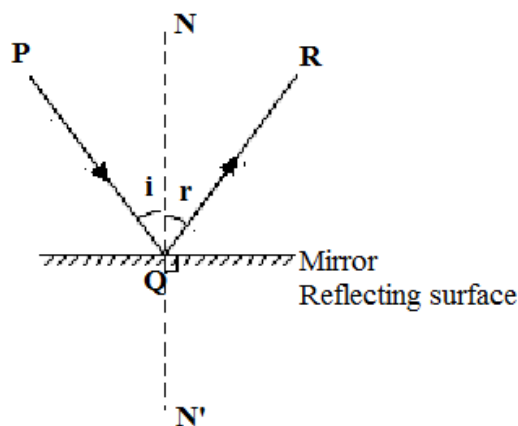

Fig:3.5.1

#### Laws of reflection

- 1) Angle of incidence is equal to angle of reflection  $\angle i = \angle r$
- 2) Incident ray, reflected ray & normal lie in same plane.

#### 3.5.2: Refraction of light

When light is allowed to fall on transparent medium such as glass then some light reflects back & some light travels in other medium. When light travels from one medium into other medium then it bends (deviates) this bending of light is called refraction

Refraction is defined as property of light on account of which light changes its path (direction) when it enters form one medium into other medium.

If incident light is perpendicular to the surface, then light passes without bending and for all other angle of incidence bending of light takes place.

When light travels form one medium to other then there is change in velocity direction as well as wavelength of light but the frequency remains unchanged.

**Snell's law or laws of refraction:**

Snell's law state that for any two media the ratio of sine angle of incidence to sine angle of refraction is constant for a given light beam.

The incident ray Refraction ray & normal lie in same plane

Thus

$$\frac{\sin i}{\sin r} = \text{const}$$

This constant is called refractive index of second medium with respect to the first medium & is denoted by  ${}^1\mu_2$ .

$$\frac{\sin i}{\sin r} = {}^1\mu_2$$



**Fig:3.5.2.1**

Case 1: when light enters form air (rare) to (denser) medium ray bends toward the normal (**Fig:3.5.2.1**)

$$\frac{\sin i}{\sin r} = \text{Costrant} > 1$$

The constant is called refractive index of glass with respect to air and is denoted by  $a^\mu g$

$$a^\mu g = \frac{\sin i}{\sin r} > 1$$

Case 2 when light enters form denser (glass) to air (rarer) medium then ray bends away from normal (**Fig:3.5.2.2**)

thus  $i < r$

$$\frac{\sin i}{\sin r} = \text{Constant} < 1$$

The constant is called refractive index of air with respect to glass and is denoted by  $g^\mu a$

$$g^\mu a = \frac{\sin i}{\sin r} < 1$$

$$g^\mu a = \frac{1}{g^\mu a}$$



### 3.5.3: Total internal Reflection (T.I.R.)

#### (Principle of optical fiber)

Consider light rays from point source in optically denser medium (glass) fall on the surface on other side which is less optically medium (air). For the rays a,b,c, there are both reflection & refraction taking place for the ray e,f no refraction only reflection take place.

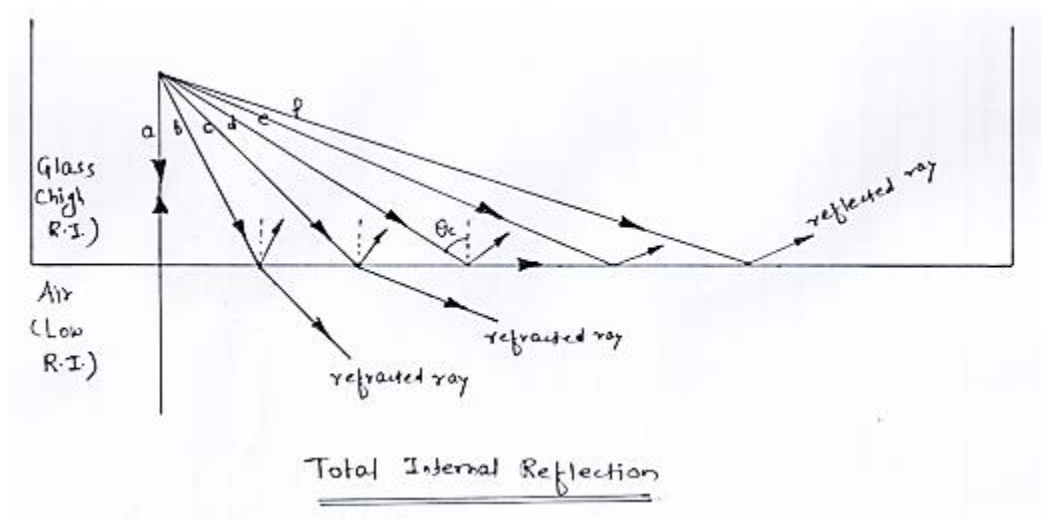

Fig 3.5.3

**Critical angle ( $\theta_c$ )-** It is the angle of incidence at which angle of refraction is  $90^\circ$   
OR

Critical angle  $\theta_c$  is defined as a particular value of angle of incidence at which refracted ray emerges along interface.

#### **Total Internal Reflection (T.I.R.) and necessary conditions**

If light travels from high R.I to low R.I. and if angle of incidence is greater than critical angle then only reflection takes place which is called Total Internal Reflection.

#### **Condition for T.I.R**

- 1) The angle of incidence should be greater than  $\theta_c$
- 2)  $\mu_1$  should be greater than  $\mu_2$

### 3.5.4: Optical fiber

Optical fiber is a thin dielectric material cables made up of (silica) glass or plastic. Optical fiber carries light (electromagnetic waves) from one end of fiber to other end because of total internal reflection

**Principle-** The optical fiber works on the principle of Total Internal Reflection (T.I.R). i.e. When monochromatic light is obliquely incident on the interface between optically denser medium & rarer medium and if angle of incidence is greater than critical angle then no refraction takes place and only reflection takes place which is called total internal reflection.

Following two conditions are necessary for T.I.R.

- 1)  $\mu_1 > \mu_2$  i.e. refractive index of first medium should be greater than second medium
- 2)  $i > e$  i.e. angle of incidence should be greater than critical angle

### 3.5.4.1: Structure (Construction) of Optical fiber

Communication optical fiber has cylindrical core surrounded with cylindrical coat of cladding coated with protective skin (insulation, jacket).

When light enters into core it propagates by means of total internal reflection at core cladding interface and emerges out from the other end

**Core-** The light is transmitted within core. The core is innermost layer. The refraction index of core is slightly greater than cladding. The typical value of refraction index of core is 1.48

**Cladding-** The cladding keeps light waves with core because refractive index of cladding is less than that of core. Typical value of refractive index of cladding is 1.46 it also provides some strength to core.

**Protective skin-** The protective skin protects fiber from moisture. This protective skin provides mechanical strength to optical cable.

Optical fiber is made from either glass (silica) or plastic

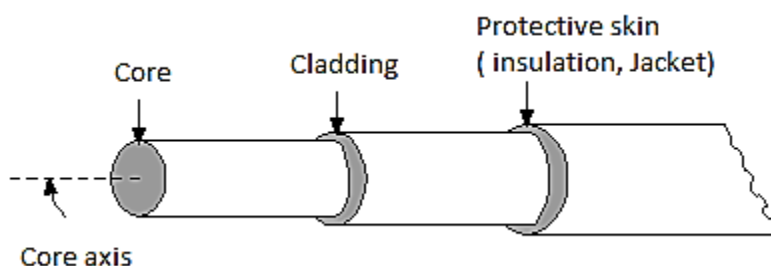

Fig:3.5.4

### 3.5.4.2: Dimensions

The length of optical fiber is normally 1km they can be joined using suitable connectors. Outer diameter of fiber ranges from 0.1 mm to 0.15mm. Core diameter ranges from  $5\mu\text{m}$  to  $600\mu\text{m}$  (typical value is approximately  $50\mu\text{m}$ ) cladding diameter varies from  $125\mu\text{m}$  to  $750\mu\text{m}$ . Thickness of protective skin varies from 30 to  $50\mu\text{m}$

### 3.5.4.3: Conditions for T.I.R. or Propagation of light through optical fiber

- 1) Refractive index of core should be greater than refractive index of cladding (i.e.  $\mu_{\text{core}} > \mu_{\text{cladding}}$ )
- 2) Entering light must have angle of incidence greater than critical angle ( $\theta_c$ )

**Critical angle ( $\theta_c$ )** - It is the angle of incidence at which angle of refraction is  $90^\circ$

OR

The critical angle is defined as the particular value of angle of incidence at which ray emerges along the interface

**Acceptance angle ( $\theta_a \text{ max}$ )-**

The maximum value of external incident angle for which light will propagate in the optical fiber

It is also called acceptance cone half angle

**Acceptance cone-**

If  $\theta_a$  is rotated around the core axis then cone is formed which is called acceptance cone.

If light is allowed to fall within this cone (tunnel) then it will propagate till far end

**Numerical aperture (N<sub>A</sub>)-**

It is the sine of maximum acceptance angle

$$N_A = \sin \theta_{a \text{ max}}$$

It measures the light gathering capacity of optical fiber.

Greater the numerical aperture greater the numerical aperture greater is the amount of light the optical fiber will accept.

**Path (propagation or transmission of light through optical fiber)**

A beam of light is focused at one end of cable if the angle of incidence of light greater than critical angle then total internal reflection takes place & light beam are reflected through the fiber. The beam bounces back and passes the cable & it exit at the other end the light which travels from one end to other end is called “light is guided” through fiber. Because of total internal reflection light beam will continue to propagate through the fiber even though it is bent number of times. More bending may cause angle of incidence to change & hence loss of light may take place. With long little bends the light will stay within the cable

**3.5.5: Path (propagation) of light through different types of optical fibers**

Depending on variation of refractive index of core & mode of propagation, the optical fibers are of different types. Path of light through different types of optical fibers is different

**3.5.5.1: Type Depending on variation of refractive index of core**

- 1) Step index optical fiber
- 2) Graded index optical fiber

Type depending on mode of propagation

- 1) Single mode optical fiber
- 2) Multimode optical fiber

Thus the different types of optical fiber are

- a) Step index single mode optical
- b) Step index multimode optical fiber
- c) Graded index multimode optical fiber

**Step index optical fiber** – In this types refractive index of core is uniform through the fiber thus if we move radially outward from core axis then there is step (sudden) change in refractive index at core cladding interface. Propagation of light through step index optical fiber is zig- zag

### Single mode step index optical fiber

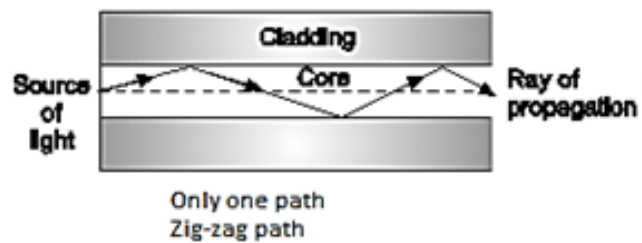

Fig:3.5.5.a

Core diameter of this fiber is very small it is about  $10\mu\text{m}$ . There is only one path of ray of propagation hence it is called single mode & the path is zig-zag i.e. in this type there is only one zig-zag path

### Multimode step index optical fiber-

Core diameter of this is larger than single mode & it is  $50\text{-}200\mu\text{m}$ . There are many paths of propagation hence it is called multimode & paths are zig-zag. Thus there are many paths that are zig-zag. Some light paths are longer & some are shorter hence some light rays exit latter some rays exit earlier

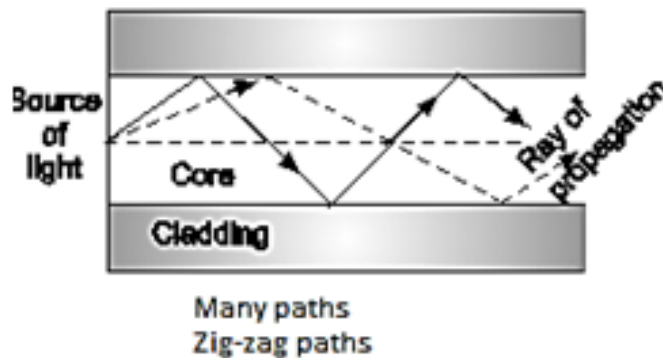
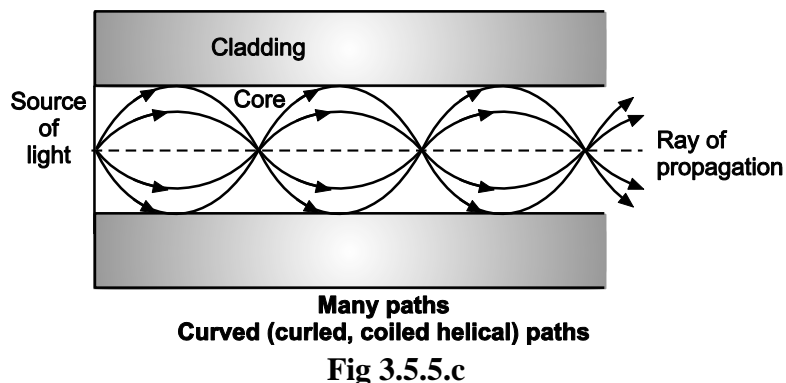

Fig 3.5.5.b

**Graded index fiber-** In this type refractive index of core is not uniform throughout the fiber. Refractive index of core at core axis is maximum & if we see radially outward from core axis there is gradual decrease in the refractive index. Refractive index of core material at core axis is maximum & it is minimum at core cladding interface. In graded index optical fiber because of different refractive indices within the core light travels with different speeds through different parts with in core path (propagation) of light through graded index optical fiber is curved (curled, coiled, helical)

### Multimode grades index optical fiber

Core diameter of this fiber varies form  $50\text{-}200\mu\text{m}$ . Because of different refractive index within core light travels with different speed longer paths are faster & shorter paths are slower. Therefore, all rays reach at same time.



### 3.5.6: Applications of optical fiber

Fiber optic cable has outstanding properties they are lighter in weight, less bulky flexible and carries large data with High speed so it has many applications

- 1) Optical fiber in communication- Because of large bandwidth it can handle number of channels hence found large applications in communication
- 3) Telephone- Using optical fiber communication we can connect faster & have clear conversations
- 4) Internet– Optical fiber can pass large data & with faster speed. This technology is used internet cables
- 5) Computer networking- networking between computer in same building is made easier & faster with the use of fiber optical cables
- 6) Used in industrial atomization system
- 7) Used for signaling purpose in military
- 8) To observe internal organs in medical field
- 9) Used in cable television
- 10) Used in defense for confidential communication
- 11) Used for transmission of digital data
- 12) Sensors- Optical fiber sensors are used to control liquid level temperature, pressure, chemical concentration etc. in automation system example if temperature changes then refractive index of optical fiber change & this property is used in temperature sensors
- 13) Used as phase modulated sensors, polarized modulated sensors

### SOLVED EXAMPLES

#### Examples on Refraction:

**Example 1 :** Find the velocity of light in a glass whose refractive index is 1.5.

**Solution: Given:**

$${}_a\mu_g = 1.5$$

Take  $v_a = 3 \times 10^8$  m/s speed of light in air

$$v_g = ?$$

We have,

$${}_a\mu_g = \frac{v_a}{v_g}$$

$$\therefore v_g = \frac{v_a}{{}_a\mu_g} = \frac{3 \times 10^8}{1.5}$$

$$\boxed{v_g = 2 \times 10^8 \text{ m/s}}$$

**Example 2:** Speed of light in diamond is  $1.2 \times 10^8$  m/s. Calculate refractive index of diamond.

**Solution: Given:**

$$v_d = 1.2 \times 10^8 \text{ m/s}$$

$$\text{Take } v_a = 3 \times 10^8 \text{ m/s}$$

$${}_a\mu_d = ?$$

We have,

$${}_a\mu_d = \frac{v_a}{v_d} = \frac{3 \times 10^8}{1.2 \times 10^8}$$

$$\boxed{{}_a\mu_d = 2.5}$$

**Example 3:** A light ray enters water medium making an angle of  $60^\circ$  with water surface. If it suffers deviation of  $15^\circ$  in water, calculate refractive index of water.

**Solution:** Ray makes an angle of  $60^\circ$  with water surface i.e. it makes an angle of  $30^\circ$  with normal to water.

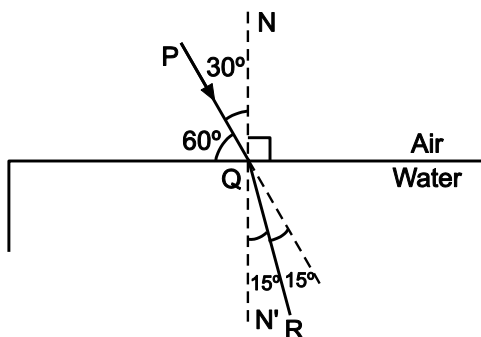

Angle of incidence,

$$i = 90 - 60 = 30^\circ$$

$$r = (30 - 15) = 15^\circ$$

Refractive index of water w.r.t. air.

$$\text{i.e. } {}_a\mu_w = \frac{\sin i}{\sin r} = \frac{\sin 30^\circ}{\sin 15^\circ}$$

$$\boxed{{}_a\mu_w = 1.93}$$

**Example 4 :** Velocity of light in water is  $2.3 \times 10^8$  m/s. Velocity of light in glass is  $2 \times 10^8$  m/s. Calculate (a) R.I. of glass w.r.t. water, (b) Also R.I. of water w.r.t. glass.

**Solution: Given:**

$$v_w = 2.3 \times 10^8 \text{ m/s}$$

$$v_g = 2 \times 10^8 \text{ m/s}$$

$${}_w\mu_g = ?, \quad {}_g\mu_w = ?$$

(a) We have,

$${}_w\mu_g = \frac{v_w}{v_g} = \frac{2.3 \times 10^8}{2 \times 10^8}$$

$\therefore$

$$\boxed{{}_w\mu_g = 1.15}$$

(b) We have,

$${}_g\mu_w = \frac{v_g}{v_w} = \frac{2 \times 10^8}{2.3 \times 10^8}$$

$$\boxed{{}_g\mu_w = 0.87}$$

**Example 5:** The refractive index of water is 1.3. The refractive index of glass is 1.5. Find the velocity of light in water and glass.

**Solution: Given:**

$${}_a\mu_w = 1.3$$

$${}_a\mu_g = 1.5$$

Take

$$v_a = 3 \times 10^8 \text{ m/s}$$

$$v_w = ?$$

$$v_g = ?$$

We have,

$${}_a\mu_w = \frac{v_a}{v_w} \quad \text{and} \quad {}_a\mu_g = \frac{v_a}{v_g}$$

$\therefore$

$$v_w = \frac{v_a}{{}_a\mu_w} \quad \text{and} \quad v_g = \frac{v_a}{{}_a\mu_g}$$

$$= \frac{3 \times 10^8}{1.3} \quad \quad \quad = \frac{3 \times 10^8}{1.5}$$

$$\boxed{v_w = 2.31 \times 10^8 \text{ m/s}}$$

$$\boxed{v_g = 2 \times 10^8 \text{ m/s}}$$

**Example 6 :** How long will light take in travelling a distance 500 m in water ? R.I. of water is  $4/3$  and velocity of light in vacuum is  $3 \times 10^8$  m/s.

**Solution: Given:** Distance = 500 m,  ${}_a\mu_w = 4/3$ ,  $v_a = 3 \times 10^8$  m/s,  $t = ?$

$${}_a\mu_w = \frac{v_a}{v_w}$$

$\therefore$

$$v_w = \frac{v_a}{{}_a\mu_w} = \frac{3 \times 10^8}{4/3}$$

$$v_w = \frac{9}{4} \times 10^8 = 2.25 \times 10^8 \text{ m/s}$$

But

$$v_w = \frac{\text{Distance covered in water}}{\text{Time}}$$

$\therefore$

$$t = \frac{\text{Distance}}{v_w} = \frac{500}{2.25 \times 10^8}$$

∴

$$t = 222.22 \times 10^{-8} \text{ sec}$$

**Examples on critical angle:**

**Example 7 :** For silicate glass optical fiber, calculate the critical angle if refractive index of core is 1.55 and refractive index of cladding is 1.35.

**Solution: Given:**  $\mu_{\text{core}} = 1.55$ ,  $\mu_{\text{clad}} = 1.35$ ,  $\theta_c = ?$

We have,

$$\theta_c = \sin^{-1} \frac{\mu_{\text{Clad}}}{\mu_{\text{core}}} = \sin^{-1} \left( \frac{1.35}{1.55} \right) = \sin^{-1} (0.871) = 60.57^\circ$$

**Example 8:** For a typical optical fiber, refractive index of core is 1.48 and refractive index of cladding is 1.46. Calculate the critical angle required.

**Solution: Given:**  $\mu_{\text{core}} = 1.48$ ,  $\mu_{\text{clad}} = 1.46$ ,  $\theta_c = ?$

We have,

$$\theta_c = \sin^{-1} \frac{\mu_{\text{Clad}}}{\mu_{\text{core}}}$$

$$\theta_c = \sin^{-1} (0.9864) = 80.57^\circ$$
**E learning websites**

1. [www.examfear.com](http://www.examfear.com)
2. [www.khanacademy.com](http://www.khanacademy.com)
3. amrita virtual labs
4. the physics classroom phet interactive simulations

**Sample MCQS****HEAT: SAMPLE MCQ**

1. Which statement is the best example of heat energy transfer by conduction.
  - a) Heat energy is transferred from the bottom of the top of a lake
  - b) Heat energy is transferred from the sun to the earth
  - c) Heat energy is transferred from the surface soil to the rocks below
  - d) Heat energy is transferred from the earth's surface to the upper atmosphere.
2. Name the method of energy transfer that requires no medium for transfer
  - a) Conduction b) convection c) radiation d) none of above
3. Heat is measured in
  - a) Joule b) calorie c) both and B d) joule / second
4. The amount of heat required to raise the temperature of 1 kg by 1<sup>0</sup>c is called as
  - a) Heat capacity B0 work capacity c) specific heat capacity d) energy capacity
5. For a gas, which pair of variables are inversely proportional to each other if the remaining conditions kept constant.
  - a) P,V    b) P,T    c) V,T    d) none of above



### OPTICS SAMPLE MCQ

6. *Snell's law states that, for any two media, the .....*
  - (a) *product of sin i to sin r is constant*
  - (b) *ratio of sin i to sin r is constant*
  - (c) *Sum of sin i and sin r is constant*
  - (d) *difference of sin i and sin r is constant*
7. *When ray of light travels from denser medium to rarer medium and if angle of incidence is greater than critical angle, then only reflection takes place. This phenomenon is known as \_\_\_\_\_.*
  - (a) *Total internal reflection*
  - (b) *total internal refraction*
  - (c) *Interference*
  - (d) *diffraction*
8. *In step index optical fiber, the refractive index of \_\_\_\_\_.*
  - (a) *Core is uniform throughout the fiber*
  - (b) *core and cladding is same*
  - (c) *Core is changing from axis to boundary*
  - (d) *none of these*
9. *In multimode step index optical fiber, for light .....*
  - (a) *There are many zig-zag paths*
  - (b) *there is only one zig-zag path*
  - (c) *There are many curved paths*
  - (d) *there is only one curved path*
10. *For a glass optical fiber, calculate the critical angle if refractive index of core is 1.5 and refractive index of cladding is 1.3.*
  - (a)  $55.23^\circ$
  - (b)  $64.25^\circ$
  - (c)  $57.83^\circ$
  - (d)  $60.07^\circ$

#### Answers

<b>1 (c)</b>	<b>2(b)</b>	<b>3(a)</b>	<b>4(c)</b>	<b>5(a)</b>
<b>6 (b)</b>	<b>7 (a)</b>	<b>8 (a)</b>	<b>9 (a)</b>	<b>10 (d)</b>

#### References

1. Engineering physics  
R.k gaur, S.S.Gupta, Dhanpat rai Pub.
2. Text book of physics for class XI & XII (Part I, Patt –II) NCERT New delhi
3. Physics standard XI, XII
4. Controller Maharashtra state, textbook bwceau, Mumbai

#### Self directed learning

1. Collect information on good and bad conductors of heat.
2. Find applications of gas laws in everyday life
3. Collect the information on specific heat capacity of gas used in industrial and engineering application
4. Find the types of optical fibres

#### Suggestion for micro project

1. Demonstrate modes of heat transfer
2. Demonstrate gas laws.
3. Determine thermal conductivity of a metal bar
4. Demonstrate phenomena of TIR

## SECTION – II [CHEMISTRY]

### Unit 4

#### CHEMICAL BONDING AND CATALYSIS

##### **Rationale:**

Chemical bonds are used to create number of chemical compounds that allow us to find new substances. Chemical bonds are extremely important to chemists, scientists, engineers and technologist. One of the most crucial reason behind the knowledge of chemical bonds is to understand the various chemical and physical properties associated with an element which technologist have to use in various engineering applications. Ex: Metals, Alloys, Polymer, adhesives etc. The knowledge of chemical reactions is so important because they not only change the property of the substances that participate in the reaction, but also store or release energy.

**Course Outcome** : Apply the catalysis process in industries.

##### **Unit Outcomes:**

- 4a. Explain the properties of given material based on the bond formation.
- 4b. Describe the molecular structure of given solid, liquid and gases.
- 4c. Describe the crystal structure of the given solids.
- 4d. Select the relevant catalyst for given application.

##### **Significance:**

Atom consists of nucleus composed of protons and neutrons and the electrons are revolving around the nucleus in the extra nuclear part of atom. In chemical bonding the electrons located in the outermost shell or orbital are involved to form different types of chemical bonds. Chemical Bonding refers to the formation of a chemical bond between two or more atoms, molecules, or ions to give rise to a chemical compound. These chemical bonds are keeping the atoms together in the resulting compound.

#### **4.1 Electronic Theory of Valency and Chemical Bonding**

##### **4.1.1 Electronic Theory of Valency**

The electronic theory of valency was originated by Kossel and Lewis in 1916 and was applied by Langmuir in 1919.

According to this theory every element has a tendency to acquire or to have stable electronic configuration ( $ns^2 np^6$ ).

The theory is based on the following facts:

- 1) The valency of an element depends on the number of electrons present in the outermost shell, such electrons are called as valency electrons. The number of valence electrons lost or gained or shared by an atom of an element in order to complete its octet and become stable is known as valency.
- 2) Atoms with eight electrons in the outermost shell (two in case of helium) are chemically stable.

3) Atoms with less than eight electrons in valence shell are chemically active and actively take part in chemical reactions.

4) Every element has a tendency to have stable electronic configuration which is achieved by forming chemical bond.

“Chemical force which holds two or more atom together is known as chemical bond”.

Following are the different types of chemical bonds formed by the different types of combinations of elements:

1) Electropositive elements + Electronegative elements → Ionic bond:

Complete transfer of electrons from electropositive element to electronegative element.

2) Electronegative elements + Electronegative elements → Covalent bond:

Mutual sharing of electrons between atoms of two electronegative elements.

3) Electropositive elements + electropositive elements → Metallic bond.

4) Electronegative elements and hydrogen atom attached to electronegative element. →  
Hydrogen bond

### Concept of valency:

**Valency:** The valency of an element is the number of electrons its atom can lose or gain or share so as to complete its octet or duplet and become stable.

**Type of valency:** i) Electrovalency ii) Covalency iii) Coordinate valency

#### i) Electrovalency

The number of electrons lost or gained by an atom of an element during the formation of an electrovalent bond is termed as its electrovalency. The elements which give up electrons to form positive ions have positive valency, while the elements which accept electrons to form negative ions have negative valency.

#### • Positive electrovalency

The valency obtained by the loss of valency electrons from the atom of metallic element so as to complete the outermost orbit is called as positive electrovalency. Generally metals atoms lose electrons and acquire positive charge.

Examples:

**Table 4.1**

Sr. No	Element	Symbol	Atomic Number	Electronic configuration	Valency	Positive electrovalency
1	Sodium	Na	11	2,8,1	+1	Na → Na <sup>+</sup> + e <sup>-</sup> (2,8,1) (2,8)
2	Maganesium	Mg	12	2,8,2	+2	Mg → Mg <sup>2+</sup> + 2e <sup>-</sup> (2,8,2) (2,8)
3	Aluminium	Al	13	2,8,3	+3	Al → Al <sup>3+</sup> + 3e <sup>-</sup> (2,8,3) (2,8)

- **Negative electrovalency**

The valency obtained by the gain of valency electrons by the atoms of non-metallic element so as to complete the outermost orbit is called as negative electrovalency. Generally non-metals gain electrons and acquire negative charge.

Examples:

**Table 4.2**

Sr. No	Element	Symbol	Atomic Number	Electronic configuration	Valency	Negative electrovalency
1	Chlorine	Cl	17	2,8,7	- 1	$\text{Cl} + e^- \rightarrow \text{Cl}^-$ (2,8,7) (2,8,8)
2	Oxygen	O	8	2,6	-2	$\text{O} + 2e^- \rightarrow \text{O}^{2-}$ (2,6) (2,8)
3	Nitrogen	N	7	2,5	-3	$\text{N} + 3e^- \rightarrow \text{N}^{3-}$ (2,5) (2,8)

**Exercise: Find out the type of valency of K (19), Ca (20), F (9) P (15), S (16)**

- ii) **Covalency:** The valency obtained by mutual sharing of electrons between the atoms of similar or dissimilar elements is termed as covalency.
- iii) **Co-ordinate valency:** The valency obtained by one sided sharing of two electrons (lone pair of e-) between the atoms of dissimilar elements is termed as co-ordinate valency.

#### 4.1.2 Types of Chemical Bonds:

**Definition:** Chemical bond is defined as “The attractive force which holds various Constituents (atom, ions etc.) together in different chemical species is called chemical bond.”

The chemical bonds are of following types.

##### 4.1.2.a Electrovalent /Ionic Bond and its Characteristics:

An ionic bond is formed due to the “electrostatic force of attraction between stable ions formed by complete transfer of electrons from atom of metallic element to atom of non-metallic element. The metallic atom loses electron to complete octet and acquire nearest inert gas configuration and form positively charged ion called as cation. The non-metallic atom gains the electrons to complete octet and acquire nearest inert gas configuration and form negatively charged ion called as anion. Positively charged cation and negatively charged anion held together by electrostatic force of attraction, the bond formed is called as ionic bond or electrovalent bond.

**For example: Formation of sodium chloride (NaCl) molecule**

1. A molecule of sodium chloride (NaCl) consists of one atom of sodium and one atom of chlorine. It is formed by electrovalent linkage (bond).
2. Sodium atom (Atomic Number = 11) has an electronic configuration (2, 8, 1) and chlorine atom (Atomic Number = 17) has an electronic configuration (2, 8, 7).

3. During the formation of sodium chloride,
  - a) Sodium atom loses its one valency electron and acquires a +1 charge and attains a stable electronic configuration of nearest inert gas element Neon (2, 8).
  - b) The electron lost by sodium atom is gained by chlorine atom and it acquires – 1 charge and attains a stable electronic configuration of nearest inert gas element Argon ( 2, 8, 8).
4. These two equal and oppositely charged ions ( $\text{Na}^+$  and  $\text{Cl}^-$  ions) which are produced, bound together by the electrostatic forces of attraction to form sodium chloride ( $\text{NaCl}$ ).

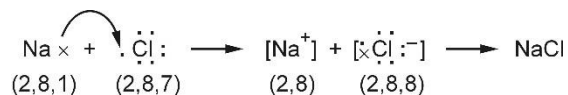

Thus electrovalency of sodium is + 1 and that of chlorine is – 1.

### For example: Formation of magnesium oxide molecule ( $\text{MgO}$ )

1. Molecules of magnesium oxide consist of one atom of magnesium and one atom of oxygen.
2. Magnesium atom (Atomic Number = 12) has electronic configuration (2, 8, 2) and oxygen (Atomic Number = 8) has electronic configuration (2, 6).
3. In the formation of Magnesium oxide molecule,
  - a) Magnesium atom loses its two valence electrons and it acquires +2 charges and attains a stable electronic configuration as that of Neon (2,8).
  - b) The lost electrons are accepted by oxygen atom and acquire – 2 charges and attains a stable electronic configuration as that of Neon (2,8).
4. These two equal and opposite charge ions ( $\text{Mg}^{2+}$  and  $\text{O}^{2-}$ ) bound together by electrostatic force of attraction and neutral Magnesium oxide molecule is formed. i.e. the two ions are bonded with ionic bond or electrovalent bond.

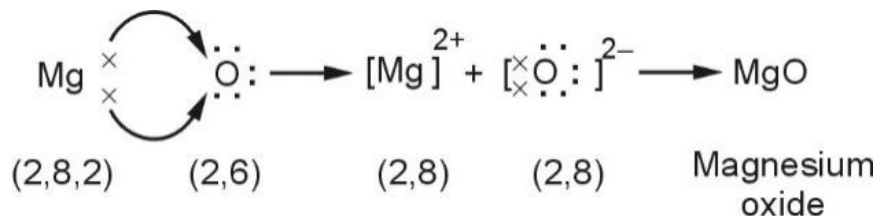

Thus the electrovalency of magnesium is + 2 and that of oxygen is – 2.

**Exercise: Explain the formation of  $\text{KCl}$ ,  $\text{MgO}$ ,  $\text{MgCl}_2$ ,  $\text{CaO}$ ,  $\text{CaCl}_2$ .**

- **Characteristic of ionic compounds:**

- i) The compounds containing ionic bond are called as ionic compounds. They are hard, crystalline solids.
- ii) They are polar in nature therefore soluble in polar solvents like water and insoluble in organic or non-polar solvents.
- iii) They have high melting and boiling points.
- iv) They are poor or bad conductors of electricity in solid state, but good conductors in aqueous state or fused (molten) state as ions are free to move.
- v) In solid state each ion is surrounded by a definite number of oppositely charged ions.

**4.1.2. b Covalent Bond and its Characteristics:**

**Covalent bond:** “The bond which is formed by mutual sharing of electrons between two similar or dissimilar atoms” is called as covalent bond. Compounds containing this type of bond are called as covalent compounds.

Covalent bonds are of three types:

- 1 Single covalent bond
- 2 Double covalent bond
- 3 Triple covalent bond

**1 Single covalent bond:** - When one electron pair ( $2e^-$ ) is shared between the atoms of similar or dissimilar element the bond formed is called as single covalent bond.

For example: Formation of  $\text{Cl}_2$  molecule:-

1. Molecules of chlorine consist of two atoms of chlorine.
2. Chlorine atom (Atomic Number = 17) has electronic configuration (2, 8, 7). Hence it is short /deficient of  $1e^-$  to complete its octet.
3. During formation of chlorine molecule, each Cl atom shares its one electron with other. Thus chlorine molecule is formed by mutual sharing of one  $e^-$  pair between two chlorine atoms. Hence there is Cl-Cl single covalent bond. Chlorine molecule contains six lone pair of electrons and one bond pair of electron.

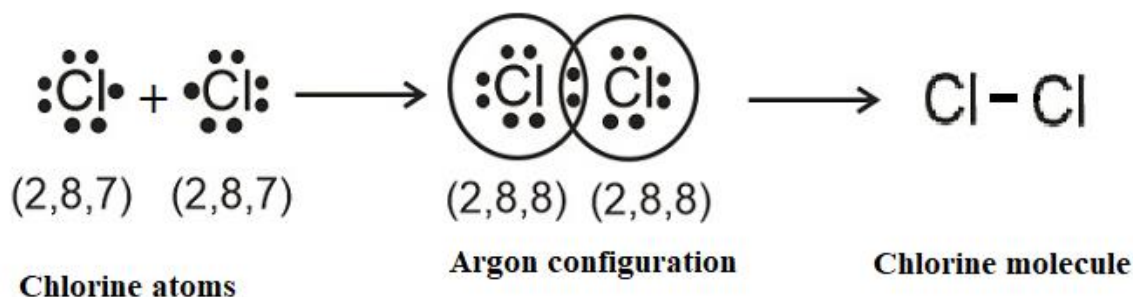

**Fig. 4.1**

**Exercise- Explain formation of  $\text{NH}_3$ ,  $\text{H}_2$ ,  $\text{H}_2\text{O}$  molecules**

**2. Double covalent bond:** - When two electron pairs ( $4e^-$ ) are shared between the atoms of similar or dissimilar element, the bond formed is called as double covalent bond.

For example: Formation of  $\text{O}_2$  molecule:-

1. Molecules of oxygen consist of two atoms of oxygen.
2. Oxygen atom (Atomic Number = 8) has electronic configuration (2,6). Hence it is short /deficient of  $2e^-$  to complete its octet.

3. During formation of oxygen molecule, each O atom shares its two electrons with other. Thus oxygen molecule is formed by mutual sharing of two e- pairs between two oxygen

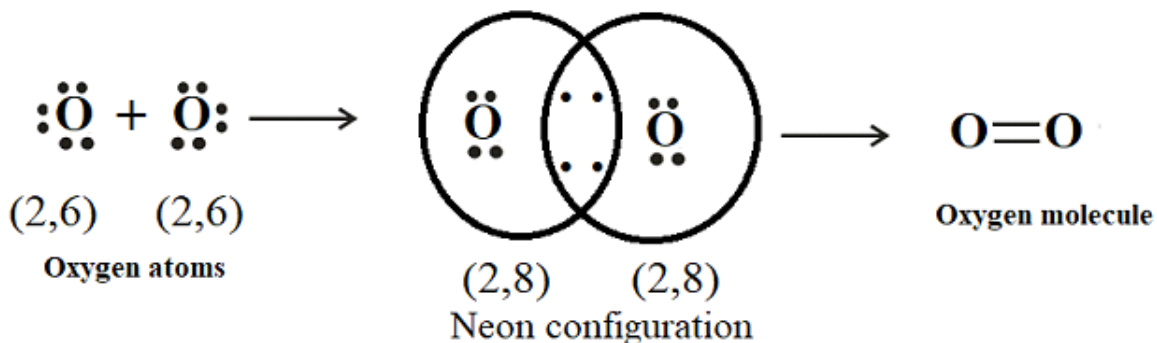

Fig. 4.2

**Exercise – Explain the formation of CO<sub>2</sub>, C<sub>2</sub>H<sub>4</sub> molecule.**

**3. Triple covalent bond:** - When three electron pairs (6e<sup>-</sup>) are shared between the atoms of similar or dissimilar element, the bond formed is called as triple covalent bond.

For example: Formation of N<sub>2</sub> molecule:-

1. Molecules of nitrogen consist of two atoms of nitrogen.
2. Nitrogen atom (Atomic Number = 7) has electronic configuration (2, 5) Hence it is short /deficient of 3e- to complete its octet.
3. During formation of nitrogen molecule, each N atom shares its three electrons with other. Thus nitrogen molecule is formed by mutual sharing of three e- pairs between two nitrogen atoms. Hence there is N ≡ N triple covalent bond. Nitrogen molecule contains two lone pair of electrons and three bond pair of electrons.

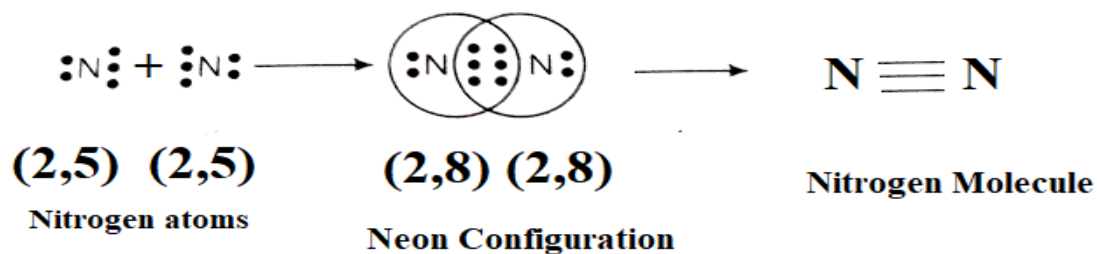

Fig. 4.3

**Exercise- Explain the formation of C<sub>2</sub>H<sub>2</sub> molecule.**

- Polar covalent bonds: When a bond is formed between dissimilar atoms, the bonding electrons will not be equally shared. The resulting bond formed is a polar covalent bond.

For example: - H<sub>2</sub>O, NH<sub>3</sub>, HF, HCl

- Non-polar covalent bonds: When a bond is formed between similar atoms, the bonding electrons are equally shared. The resulting bond formed is a non-polar covalent bond.
- Examples:- H<sub>2</sub>, Cl<sub>2</sub>, N<sub>2</sub>, O<sub>2</sub>

Covalent bond is formed between non-metals. Covalent bond is represented by solid line —

• **Characteristics of covalent compounds**

- 1) They have low melting and boiling points.
- 2) They are bad conductor of heat and electricity.
- 3) They are insoluble in polar solvents like water and soluble in organic solvents like benzene, carbon tetra chloride.
- 4) They are soft, easily fusible and volatile.
- 5) They exist mostly in gaseous or liquid state.

**4.1.2. c Co-ordinate Covalent Bond or Dative bond:**

“The atom having a lone pairs of electrons shares its lone pair of electrons to another atom which is deficient of two electrons; the resulting bond formed is called as co-ordinate bond.

The atom which donates a pair of electrons is called as ‘donor’ and the other atom which accepts the electrons is called as ‘acceptor’. The co-ordinate bond is represented by an arrow (→). The head of arrow is directed towards acceptor.

**Example: Formation of NH<sub>4</sub><sup>+</sup> ion:**

This ion formed by the combination of NH<sub>3</sub> molecule and H<sup>+</sup> ion. In NH<sub>3</sub> molecule each of three H-atoms is linked to N-atom by a covalent bond. Thus in this molecule N-atom is left with one lone pair of electron after completing its, octet by sharing three of its valence shell electrons with three H-atoms. This lone pair of electron on N-atom is donated to H<sup>+</sup> ion and thus N → H, co-ordinate bond is formed in NH<sub>4</sub><sup>+</sup> ion.

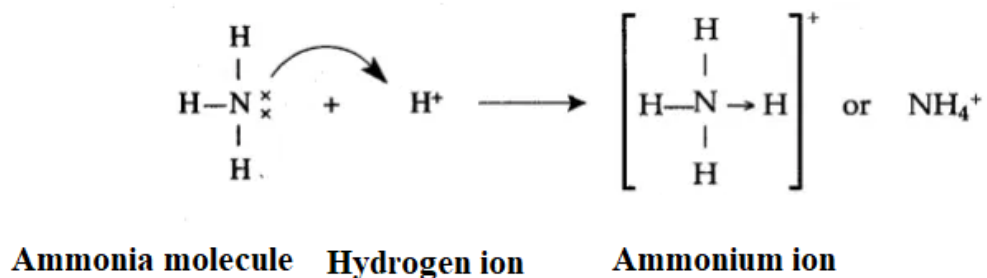

Fig. 4.4



**Formation of NH<sub>4</sub>Cl molecule**

The bond in ammonia molecule is covalent type. In presence of HCl, an unshared pair of electron of nitrogen in ammonia forms coordinate bond with proton of hydrochloric acid forming positively charged ammonium ion. This ammonium ion forms electrovalent bond with chloride ion and ammonium chloride molecule is formed. Thus ammonium chloride contain electrovalent, covalent and coordinate bond.

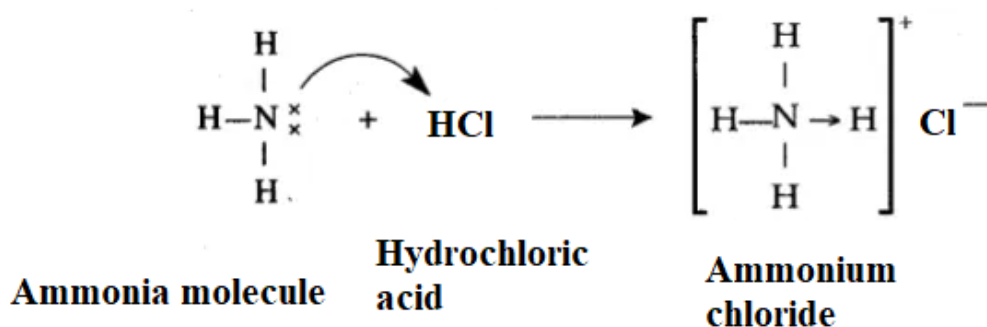

Fig. 4.5

- **Characteristics of co-ordination compounds**

- 1) The B.P. and M.P. of these compounds have intermediate value between electrovalent and covalent compounds.
- 2) The bond of this compound is directional.
- 3) They are slightly soluble in water.
- 4) Most of the compounds are soluble in organic solvents.

**4.1.2.d Hydrogen Bond - Types and its Characteristics:**

Hydrogen bond is formed between electronegative atom in one molecule and electronegative atom in a same or another molecule.

If hydrogen atom in a molecule is bonded covalently to any of the strongly electronegative atom like nitrogen, oxygen or fluorine, the electrons of the covalent bond are shifted towards the more electronegative atom. Hence hydrogen acquires additional positive charge and shows ability to form additional bond with strongly electronegative atom in the vicinity. The additional bond is called hydrogen bond.

“The attractive force of attraction between covalently bonded H-atom in one molecule and highly electronegative atom like nitrogen, oxygen or fluorine present in a same molecule or in other molecule is called hydrogen bond and the phenomenon is called hydrogen bonding”.

Hydrogen bond is represented by dotted line (-----)

Types of hydrogen bond:

**1) Intermolecular hydrogen bonding:**

Inter-molecular hydrogen bonding occurs in between two or more molecules of the same or different compounds. Hydrogen atom acts as a bridge between two molecules.

Example: Intermolecular hydrogen bond in water.

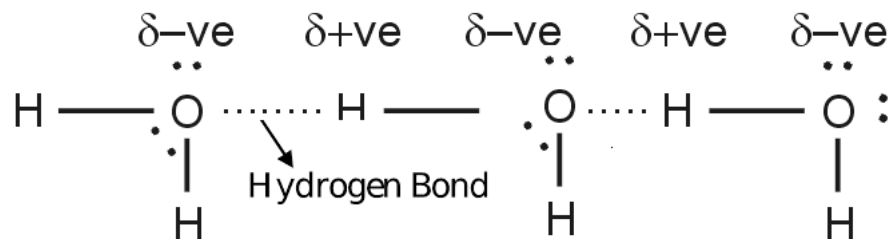

Fig. 4.6

Presence of hydrogen bond increases the boiling point of water. The hydrogen bonds link the water molecules together to form a huge molecular aggregate. Extra energy is thus required to break the hydrogen bonds which raise the boiling point.

For example: Intermolecular hydrogen bond in HF molecule.

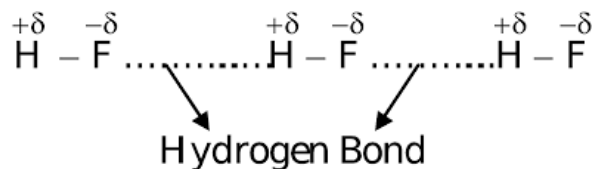
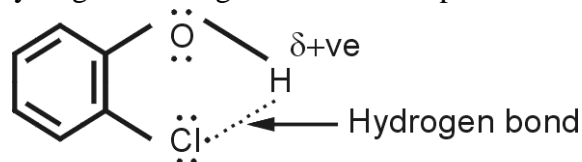

Fig. 4.7

## 2) Intramolecular hydrogen bonding:

Intramolecular hydrogen bonding formed when hydrogen atom is in between the two highly electronegative (O, N, F) atoms present within the same molecule.

Example: Intramolecular hydrogen bonding in Ortho-chlorophenol.



Example: Intramolecular hydrogen bonding in Ortho-nitrophenol.

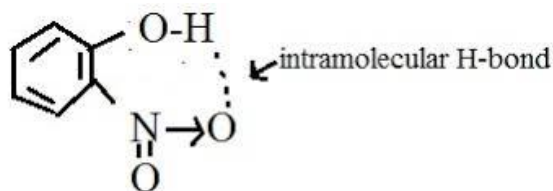

### • Characteristics of H-bonded compounds :

- 1) The hydrogen bond is one of the strongest intermolecular attractions, but weaker than a covalent or an ionic bond.

- 2) Intermolecular hydrogen bonding is responsible for the high boiling point of water.
- 3) Water accumulates in cells of animals and plants due to hydrogen bond.
- 4) The strength of cement concrete is due to the hydrogen bond.

#### 4.1.2.e Metallic Bond - Types and its Characteristics:

The metal or alloys, i.e the metallic crystal is held together by the strong force of attraction between the positive metal ions (called kernels) immersed in sea of mobile electrons. Each metal atom contributes one or more electrons towards the sea of mobile electrons. These free mobile electrons present in the sea are responsible for electrical conductivity and also thermal conductivity of metals.

“The forces present between the metal ions are metallic bonds”.

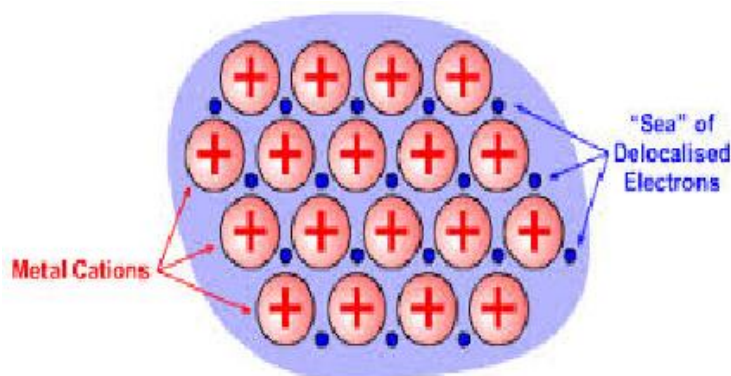

Fig. 4.8

#### Characteristics of metallic (crystal) compounds:

- 1) Metallic crystals may be hard as well as soft.
- 2) They are good conductor of heat and electricity.
- 3) They have metallic luster.
- 4) They are malleable and ductile.
- 5) The strength of metallic bond increases with
  - a) The number of valence electrons.
  - b) The decrease in size of the atom.

Example: All metals like copper, iron, aluminum and their alloys

#### 4.1.3 Intermolecular Force of Attraction

In polar as well as in non-polar substances force of attraction is present between the molecules. The magnitude of this force is found to be maximum in solid substances and minimum in gaseous substances. It is called as intermolecular force of attraction. It was first discovered by Vander Waal and was named as Vander Waal's force of attraction.

##### • Vander Waal's force of attraction :

“Weak forces of attraction existing between molecules which cannot be explained on the basis of any other chemical forces of attraction are called as Vander Waal's force of attraction”.

Following four factors affect the Vander Waal's force of attraction.

- a) Molecular size
- b) Number of electrons in the molecule
- c) Average distance between two molecules
- d) Surface area of molecule.

**Table 4.1**

	<b>Ionic compounds</b>	<b>Covalent compounds</b>
1)	The compounds which are formed by complete transfer of electrons from one atom to other are called as ionic compounds.	The compounds which are formed by mutual sharing of electrons between two atoms are called as covalent compounds.
2)	In solid state they are bad conductors and in liquid state they are good conductors of heat and electricity.	They are bad conductors of heat and electricity.
3)	They have high Melting Point (M.P.) and Boiling Point (B.P.).	Comparatively they have low Melting Point (M.P.) and Boiling Point (B.P.).
4)	Generally they are insoluble in non-polar solvents and soluble in polar solvents like water. For example: NaCl, KCl,	Generally they are soluble in non-polar solvents and insoluble in polar solvents like water. For example: Cl <sub>2</sub> , CCl <sub>4</sub> .

**Table 4.2**

<b>Sr. No.</b>	<b>Ionic bond</b>	<b>Metallic bond</b>
1)	The bond which is formed by complete transfer of electrons from one atom to other are called as ionic bond.	Metallic bonding is the force of attraction between valence electrons and the positive metal ions.
2)	Ionic bond explains properties of ionic solids, such as brittleness, hardness etc.	Metallic bond explains many properties of metals like ductility, malleability. etc.
3)	Due to presence of strong electrostatic force of attraction an ionic bond is found to be strong.	The strength of the bond depends on the number of available free electrons.

**Table 4.3**

<b>Sr. No.</b>	<b>Covalent bond</b>	<b>Metallic bond</b>
1)	The bond which is formed by mutual sharing of electrons between two atoms is called as covalent bond.	Metallic bonding is the force of attraction between valence electrons and the positive metal ions.
2)	This bond is directional.	Metallic bond is non-directional.
3)	Covalent bonded compounds are bad conductor of electricity.	Metallic bonded compounds (Metals) are good conductor of electricity.

## 4.2 Significance

Solids are substances that are rigid, have a definite shape and the particles are tightly packed in orderly repeating manner or irregularly. The particles atoms, ions and molecules constitute the solid. These constitute particles occupy fixed position in the solid and do not move from place to place. They can only vibrate or oscillate about their positions.

### Molecular Arrangement in Solid, Liquid and Gases

- **Molecular arrangement in solid:**

In solids the molecules are closely packed. They have least amount of intermolecular spaces. The force of attraction between the molecules is very strong and free motion of molecules is not possible. That is why solids are rigid and retain their shape.

For example: Metals

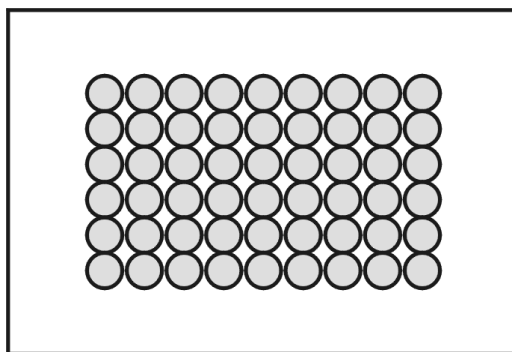

Fig. 4.9

- **Molecular arrangement in liquids :**

In liquids the molecules are loosely packed. There are large intermolecular spaces in liquids. The force of attraction between the molecules is small and motion of molecules is possible. That's why liquids are not rigid and they don't have their own shape. They take the shape of the container.

For example: Water

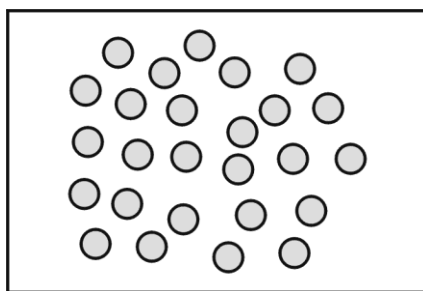

Fig.4.10

- **Molecular arrangement in gases :**

In a gas the molecules are separated from one another by wide spaces. The force of attraction between the molecules is least and the molecules have maximum freedom of motion. Hence the gas has neither a definite shape nor a definite volume.

Gases and liquids are called fluids because of their ability to flow.

For example: Air.

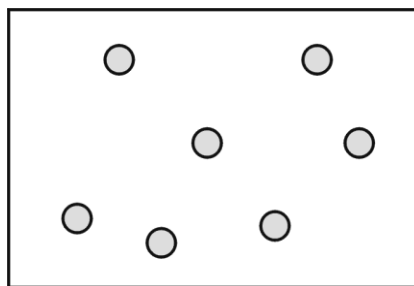

Fig . 4.11

Table 4.4

Solid	Liquid	Gases
Rigid	Not rigid	Not rigid
Fixed shape	No fixed shape	No fixed shape
Fixed volume	Fixed volume	No fixed volume

#### 4.3. Classification of solid on the basis of bond type

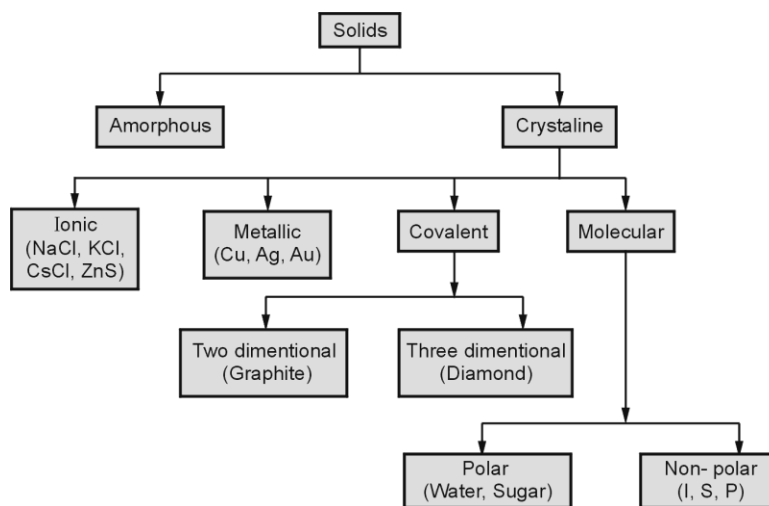

Fig. 4.4.4

- **Crystalline solids:** The substances whose constituent particles (atoms, ions or molecules) are arranged in definite orderly arrangements are called crystalline solids.

Many naturally occurring solid substances occur in the crystalline form. X-ray diffraction shown that the regular arrangement of the constituents (atoms, ions, molecules) extends throughout three dimensional networks.

- Examples: Sodium chloride, sulphur, diamond, graphite, sugar.
- **Properties of crystalline solids**

- 1) The crystalline solids exhibit regular repeating structure represented by unit cells.
- 2) These are characterized by long range order.

- 3) These solids usually show sharp melting points.
  - 4) The crystalline solids are anisotropic. Therefore, the physical properties of crystalline solids are different in different directions - like electrical conductivity, refractive index, thermal expansion etc.
  - 5) When crystalline solid is cut with a sharp knife, it cleaved along perfect directions.
- **Amorphous solids:** The substances whose constituent particles are not arranged in an orderly manner are called amorphous solids.
  - Examples: Plastics, rubber, starch, proteins, glass, coal, coke etc.
  - **Properties of amorphous solids.**
    - 1) The amorphous solids do not have regular arrangement of particles but are randomly arranged in three dimensions.
    - 2) They do not have specific long range order.
    - 3) They do not have sharp melting points.
    - 4) The amorphous solids are isotropic. Therefore their physical properties are same in all directions.
    - 5) When an amorphous solid is cut with a sharp knife, it results in an irregular breakage.

**Differences between crystalline solids and amorphous solids:**

**Table 4.5**

Sr. No.	Crystalline solids	Amorphous solids
1	They have definite arrangement of atoms, ions or molecules.	They have random arrangement of atoms, ions or molecules.
2	They have sharp melting points.	They do not have sharp melting points.
3	They have definite geometry.	They do not have definite geometry.
4	They are anisotropic.	They are isotropic.
5	Cleavage is uniform.	Cleavage is not uniform.
6	Examples : Sodium chloride, diamond, graphite , etc.	Examples: Glass, rubber, plastic.

**Classification of crystalline solids:**

The crystalline solids can be classified into four types depending on the nature of intermolecular forces operating in them.

The structures of different types of solids are discussed below:

**1) Molecular solids:** These are the crystalline substances in which constituent particles are molecules which are held together by dispersion forces, dipole-dipole forces or hydrogen bonds.

**Types of Molecular solid:****Table 4.6**

Type of Molecular solid	Intermolecular forces	Example
1.Polar molecular solid	Dipole-dipole forces	Solid HCl, Solid NH <sub>3</sub>
2.Non Polar molecular solid	Dispersion forces or London forces	Solid H <sub>2</sub> , I <sub>2</sub> , CO <sub>2</sub>
3. Hydrogen bonded molecular solid	Hydrogen bonds.	Solid water ( Ice )

**2) Ionic solids:** - These are the crystalline substances in which constituent particles are oppositely charged ions which are held together by very strong electrostatic force of attraction. These forces of attraction are very strong and therefore the ionic solid shows higher melting point.

For example: Crystalline NaCl and KNO<sub>3</sub>

**Structure of sodium chloride**

Fig. 4.11

In sodium chloride, the ions are cubic close packed (ccp) /Face centered Cubic packed crystal. Sodium ions are surrounded by six chloride ions. Similarly each chloride ion is surrounded by six sodium ions.

**3) Covalent solids:** The constituent particles of covalent solid are atoms which are held by strong covalent bonds. The bonding extends throughout the crystal and results in a giant interlocking structure as the covalent bond is directional.

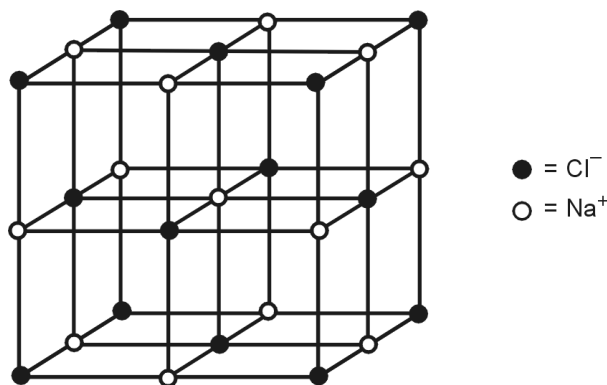

a) **Structure of diamond**

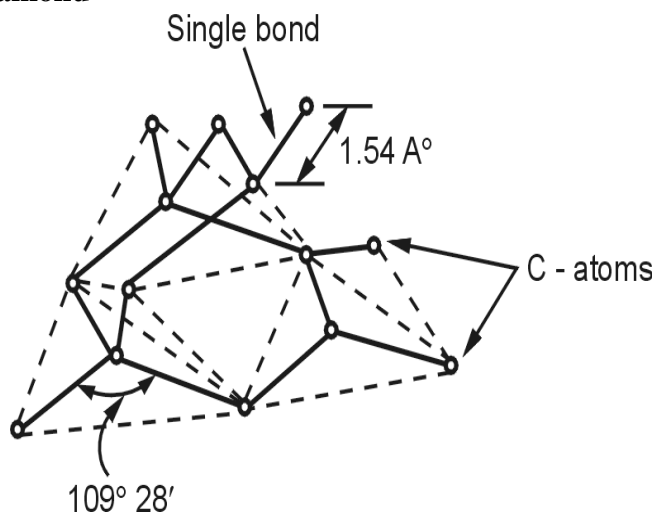

**Fig. 4.12**

In the structure of diamond, each carbon atom is covalently bonded to four other carbon atoms. It has tetrahedral arrangement. Due to presence of strong covalent bonds between carbon atoms, diamond is extremely hard, brittle, having high melting point and poor conductor of electricity.

b) **Structure of graphite:**

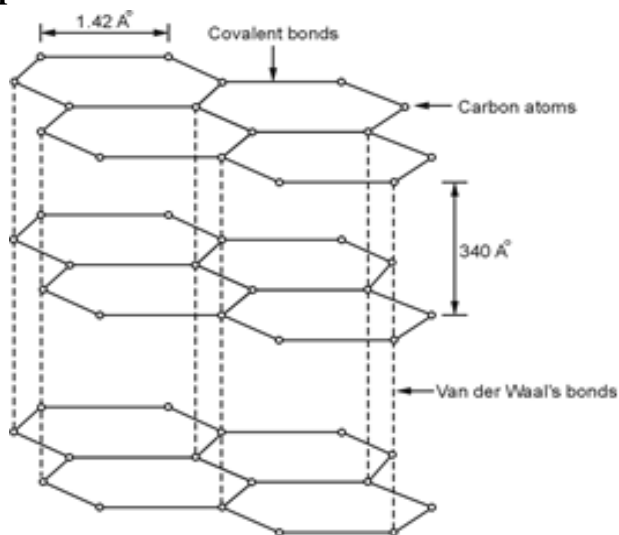

**Fig. 4.13**

In graphite, each carbon atom is covalently bonded by three other carbon atoms in a plane forming hexagonal network structure and the planes of layers are held parallel by weak Van der Waal's forces. The weak Van der Waal's forces are responsible for soft nature of graphite. The electrons forming  $\pi$  bonds in the rings of graphite are delocalized and are relatively free to move under the influence of electric field hence it a good conductor of electricity and used as an inert electrode in electrolysis.

4) Metallic solids: These are the crystalline substances in which constituent particles are

Positive ions i.e. metal atoms immersed in a sea of mobile electrons. In metallic solids, the metal atom occupies fixed positions but their valence electrons are mobile.

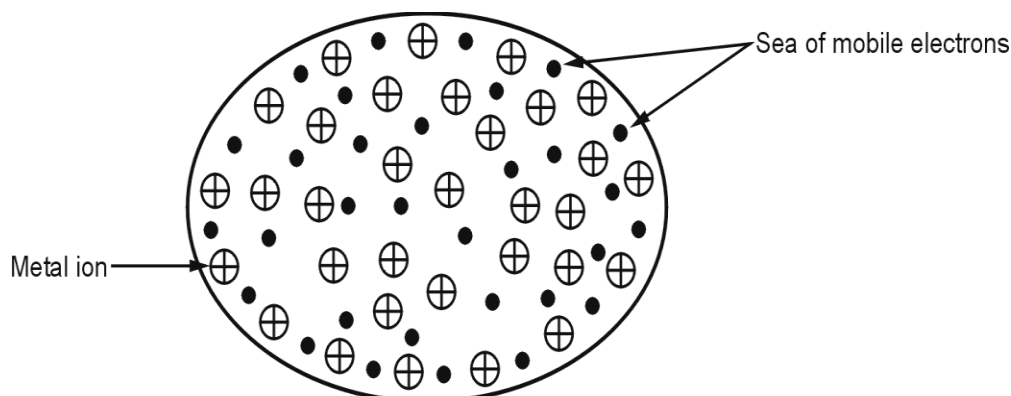

Fig. 4.14

For example: All metallic elements like Cu, Na, Fe, Zn and their alloys.

### 4.3.2 Properties of metallic solids

The properties of metallic solids can be explained on the basis of electron sea models as follows:

1) **Metallic lustre:** The bright lustre of metal is due to presence of delocalised mobile electrons. When a beam of light falls on the metallic surface, the loosely held electrons absorb photons of light and start oscillating to and fro at a frequency equal to that of incident light. The oscillating electrons emit electromagnetic energy in the form of light. As a result, the incident light appears to be reflected from metal surface and the surface exhibits shining appearance.

### 2) Electrical conductivity:

The electrical conductivity of a metal is due the presence of mobile valence electrons. When a potential difference is applied across the metal, the free mobile electrons move readily towards positive electrode. These electrons simultaneously replaced by the electrons coming from the negative electrode. This constitutes electrical conductivity.

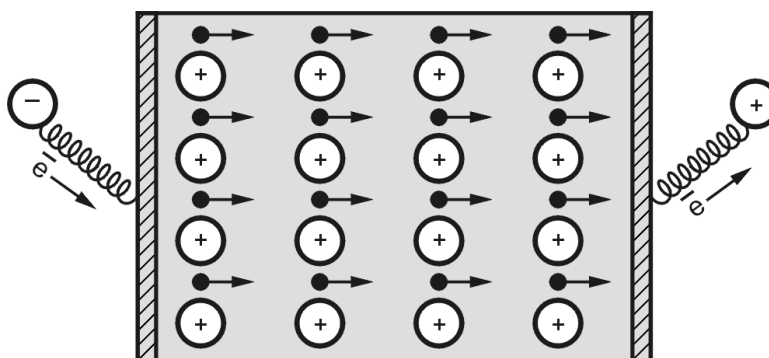
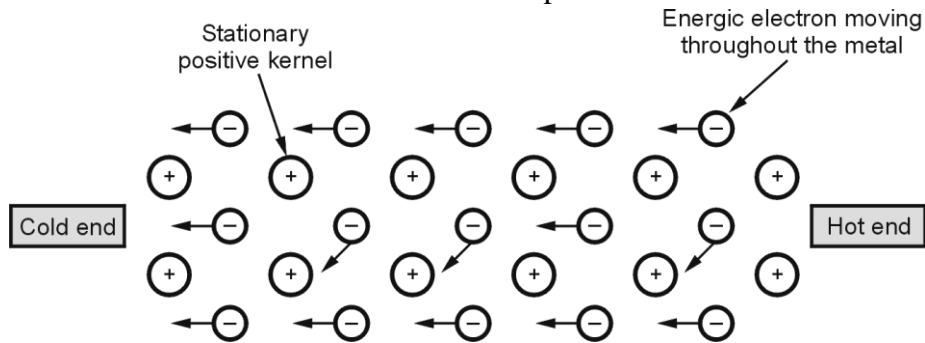

Fig. 4.13

**2) Thermal conductivity:**

The thermal conductivity of metal is due to the presence of high valency electrons. When the metal is heated, the kinetic energy of electrons in that region increases. As the electrons in metallic crystal are free and mobile, these energetic electrons move rapidly to the cooler parts and some of their thermal energy is transferred to these parts by means of collision.

Therefore, the heat is transferred from hotter to cooler parts of metal.



**Fig.4.14**

**4) Malleability and ductility:**

In the metal the valency electrons are spread all over the crystal due to this the metallic bond is non-directional. Whenever any stress or force is applied on metal, the position of positive metallic kernels is changed without destroying the crystal. Due to slippage of one layer of kernels relative to adjacent layers of kernels the metallic lattice get deformed. The deforming forces simply move the kernels from one lattice site to another. The nearest neighbors can thus be changed easily and new metal bonds can be formed readily, explains the malleability (beaten into sheets) and ductility (drawn into wires).

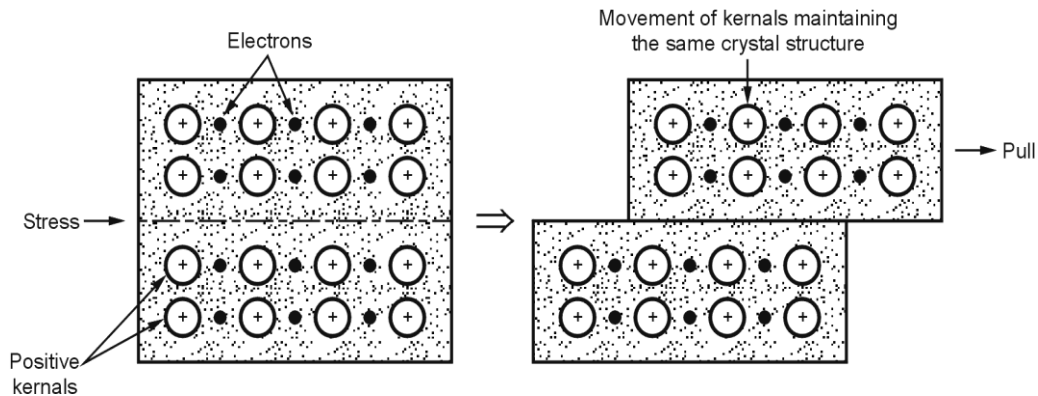

**Fig.4.15**

**5) Tensile strength or tenacity**

Tensile strength is the ability of metal to resist pull without breaking. Metals have high tenacity because there is a high electrostatic force of attraction between the positively charged kernels and sea of electrons.

**6) Elasticity in metals:**

Elasticity is the property of metal by virtue of which metal can regain its original shape as soon as the stretching force is released. In the metallic crystal elasticity is due to the ease with which positive kernels in metallic lattice can slide from one site to another.

**7) Hardness:**

Hardness is the property of metal by virtue of which metal can resist wear or abrasion and penetration. The hardness is due to the strength of metallic bond. The strength of bond based on two factors;

- i) Number of valence electrons: Greater the number of valence electrons stronger is the metallic bond.
- ii) Size of kernel: Smaller the size of kernel of metal atom, strong attraction of mobile electrons and therefore stronger is the metallic bond.

**4.3.3 Unit Cell and Crystal Lattices**

- The crystalline solids have definite orderly arrangement of their constituent particles in three dimensions. The positions of these particles in a crystal, relative to one another are usually shown by points. The arrangement of an infinite set of these points is called space lattice.
- Lattice point : The point which represents the position of constituent particles in a crystal  
**Lattices are called as lattice points.**

**1) One dimensional lattice points (along one axis)**

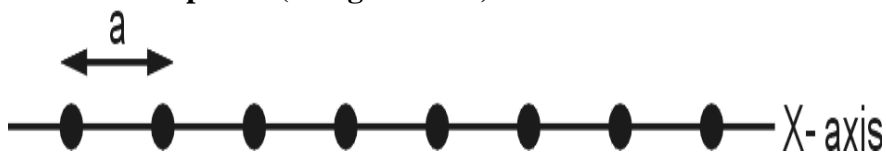

**Fig. 4.16**

**2) Two dimensional lattice points (Along x and y axis)**

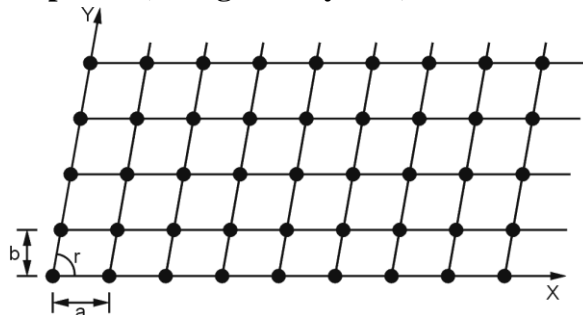

**Fig. 4.17**

### 3) Three dimensional lattice points (Along x, y and z axis)

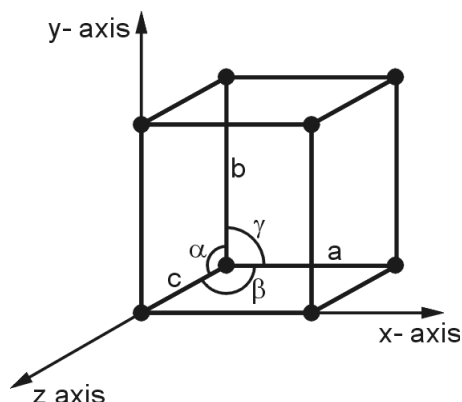

**Fig. 4.18**

A crystal lattice is a ordered set of constituent particles in three dimension. The constituent particles are represented by lattice points. The lattice point may be atom, ion or molecule.

- Space lattice or Crystal lattice “An arrangement of points showing how constituent particles (atoms, ions or molecules) of a crystal are arranged at different positions in three dimensional spaces is called as space lattice”.

French mathematician Bravais proved that lattice points can be arranged in maximum of fourteen types. The arrangement is called **Bravais lattices**.

- **Unit cell :**

It is observed that in a space lattice, we can select a group of lattice points which is repeated again and again in the whole crystal lattice. The smallest repeating pattern in a crystal structure is called as the unit cell. Unit cell shows the shape of the entire crystal. The complete crystal lattice can be obtained by extending the unit cell in all the three directions. “Unit cell is defined as the smallest three dimensional repeating portion of a space lattice which when repeated over again and again in different direction producing the complete crystal lattice”.

**Parameters of Unit cell.**

The unit cell is characterized by

- Its lengths along three edges a, b and c.
- The angles  $\alpha$ ,  $\beta$ ,  $\gamma$ . between the pairs of edges

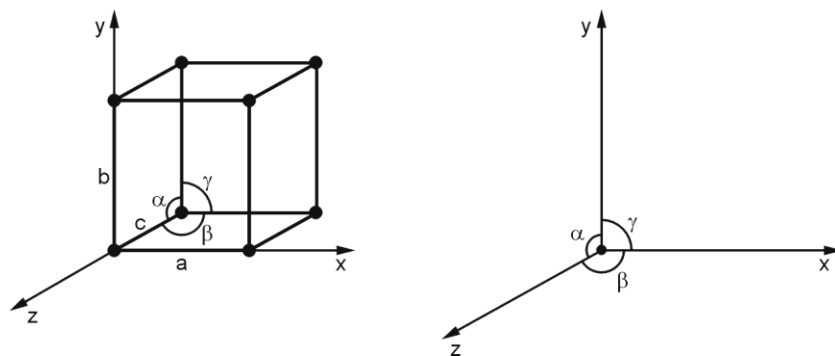

**Fig.4.19**

### Types of Crystal System:

There are basically two types of unit cell constituting different crystal system. These are

- i) Primitive or simple unit cells: These are unit cells which have points or particles only at corners.
- ii) Non- Primitive or centred unit cells: These are unit cells which have points or particles at corners as well as at some other points.

The centred unit cells are of three types:

- a) Body centred unit cell: These are unit cells which have points or particles at corners as well as at the body centre of unit cell.
- b) Face centred unit cell: These are unit cells which have points or particles at corners as well as at the centre of each faces.
- c) End centred unit cell: These are unit cells which have points or particles at corners as well as at centre of two opposite faces .

### Seven Crystal systems:

- The unit cells have **seven** different types of simple or primitive unit cell among crystal namely
  - i) Cubic
  - ii) Tetragonal
  - iii) Orthorhombic
  - iv) Hexagonal
  - v) Rhombohedral
  - vi) Monoclinic
  - vii) Triclinic

- **Types of cubic lattices:** All the edges are of equal length and are at right angle to each other.

**i. e.  $a = b = c$  and  $\alpha = \beta = \gamma = 90^\circ$ .** It is observed that a cubic unit cell has three types of lattices.

- 1) Simple Cubic unit cell (SC) or Primitive unit cell
- 2) Body Centred Cubic unit cell (BCC)
- 3) Face Centred Cubic unit cell (FCC)

• **Calculation of number of particles per unit cell :** The number of atoms in unit cell is calculated by following rules :

- 1) The atoms present at the corner of a unit cell are shared by eight another unit cells. Therefore, each atom contributes  $1/8$  to the unit cell.
- 2) The atom present at the face centred is shared by two unit cells. Therefore, contributes  $1/2$  to the unit cell.
- 3) The atom present within the body of the unit cell is shared by no other unit cell. Therefore, each atom contributes 1 to the unit cell.
- 4) The atoms present on the edge are shared by four unit cells. Hence, each atom contributes  $1/4$  to the unit cell.

### 1) Simple Cubic unit cell (SC)

In this type of unit cell, constituent particles (atoms, ions, molecules) are present only at the corners of the unit cell. Simple Cubic unit cell consist of total eight atoms at the corner of cube.

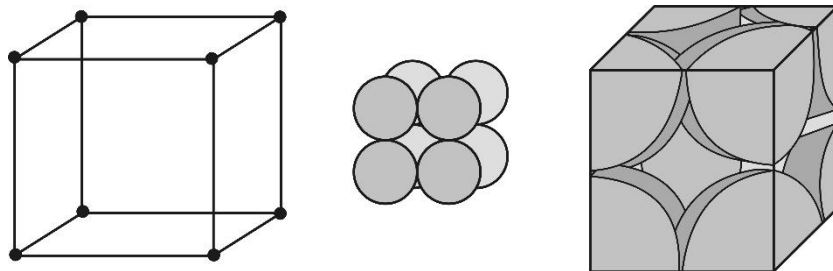

Fig. 4.20

The atoms present at the corner of a unit cell are shared by eight another unit cells. Therefore, each atom contributes  $1/8$  to the unit cell. **Hence in Simple cubic unit cell**, number of atoms per  $= (8 \times 1/8) = 1$  atom.

### 2) Body Centred Cubic unit cell (BCC)

In this type of unit cell, atoms are present at the corners of cube i. e eight atoms at corner and one at the center of the unit cell.

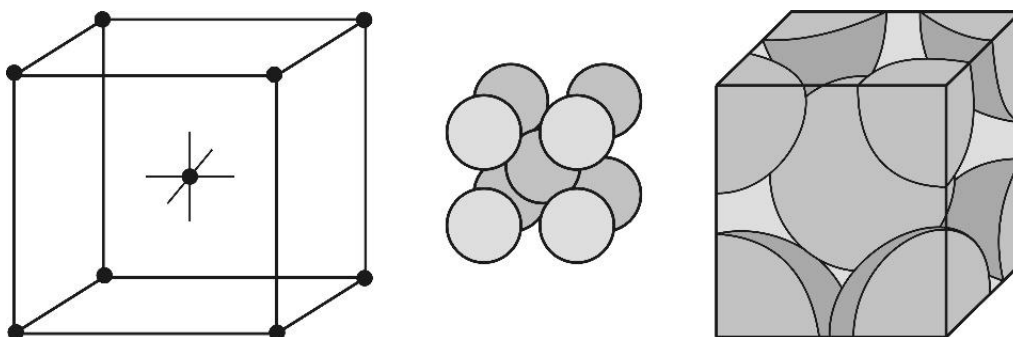

Fig. 4.21

i) Eight atoms of the corners  $= 8 \times 1/8 = 1$  atom.

ii) Atoms at the body centre  $= 1$  atom.

Hence in **Body centered cubic unit cell**, number of atoms per unit cell  
 $= 1 + 1 = 2$  atoms.

### 3) Face Centred Cubic unit cell (FCC)

In this type of unit cell, atoms are present at the corners i. e eight atoms at corner and at the center of each face i.e six atoms at the center of six faces of the unit cell.

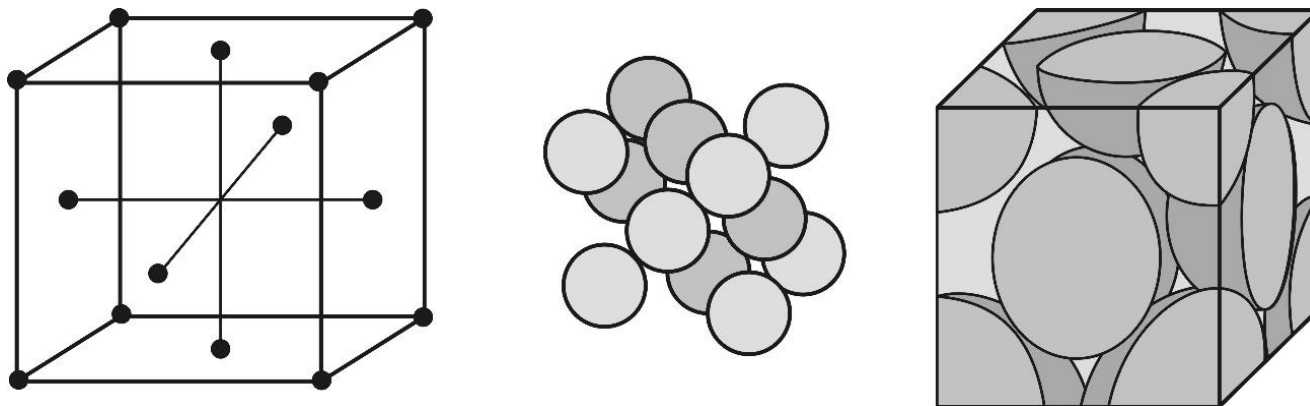

**Fig. 4.23**

i) Eight atoms of the corners =  $8 \times 1/8 = 1$  atom.

ii) Atoms at each of the six face centres =  $(6 \times 1/2) = 3$  atoms.

Hence in **Face centered cubic unit cell**, number of atoms per cubic unit cell =  $1 + 3 = 4$  atoms.

### **Packing of crystals:**

When crystal forms, the constituents particle (atoms, ions, molecules) get closely packed together in such a way that they occupy the maximum available space. This type of packing is called close packing. To understand packing of constituent particles of crystal, all spheres are considered of equal size.

**Coordination number:** The number of atoms/sphere touching a given sphere is called its coordination number. i.e. The number of atoms or ions immediately surrounding a central atom in a crystal lattice is called as coordination number

#### **1. Simple cubic packing crystal:**

Unit parameters of unit cell of this crystal are.  **$a = b = c$  and  $\alpha = \beta = \gamma = 90^\circ$ .**

In this type of packing, constituent particles (atoms, ions, molecules) of first layer are placed side by side. The atoms of next layer are placed directly above the atom of the first layer. Each atom is in direct contact with six atoms i.e. four in its plane, one atom in the layer above it and one in the layer below it.

Hence the coordination number of simple cubic packing crystal is 6.

Example: Polonium (Po)



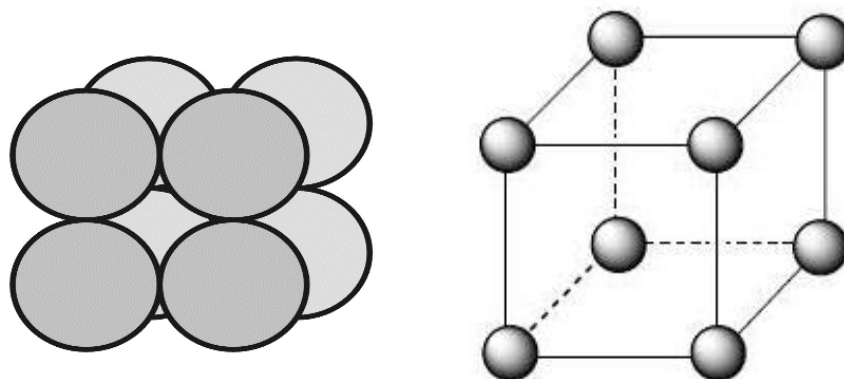

Fig. 4.24

**2. Body centered cubic (BCC) crystal:**

Unit parameters of unit cell of this crystal are.  $a = b = c$  and  $\alpha = \beta = \gamma = 90^\circ$ .

In this type of packing the spheres of the first layer are arranged like the spheres in simple cubic packing. The spheres of the second layer are not directly placed above the spheres of the first layer rather they fit into the holes/voids between the adjacent spheres of the first layer. The third layer is exactly similar to first layer. Each atom touches four atoms in the layer above it and four in the layer below its plane.

Hence the coordination number of body centered cubic packing crystal is 8.

Example: Iron (Fe), Chromium (Cr), Tungsten (W)

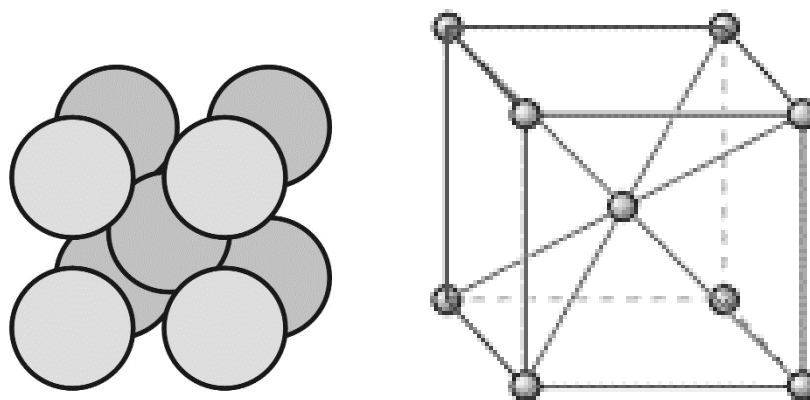
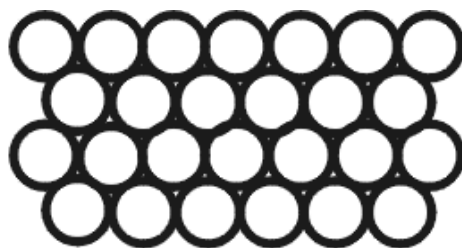

Fig.4.25

**3. Hexagonal close pack (HCP) crystal:**

Unit parameters of unit cell of this crystal are.  $a = b \neq c$  and  $\alpha = \beta = 90^\circ, \gamma = 120^\circ$ .

The spheres are packed in such a way that the spheres in every second row are placed in the depressions or interstices between the spheres of the first row. Each sphere or atom has six closest neighbours.



## (Hexagonal close packing)

Fig. 4.26

Further extending the packing in third row, the spheres will be vertically aligned with spheres in the first row. This gives rise to hexagonal close packing (hcp).

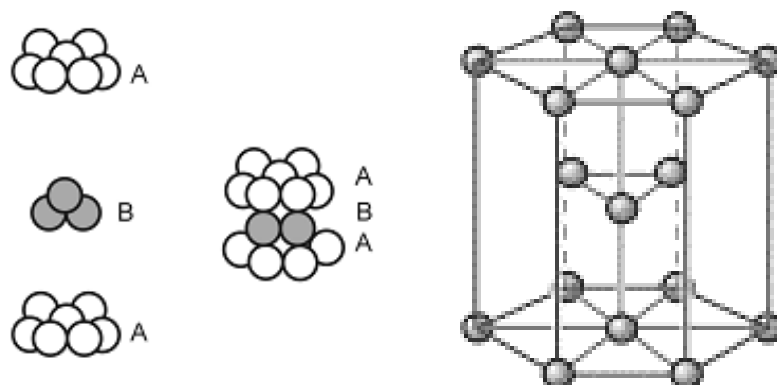

### Hexagonal close packing (ABABAB...)

Fig. 4.26

If the spheres of first layer are labelled as A and the spheres of second layer are labelled as B. Then the third layer is also labelled as A. Hence in hcp, the pattern is ABABAB ..... is called hexagonal close packing or hcp. Each atom in an hcp is surrounded by 12 nearest neighbours, six are in the planar hexagonal layer B and six (three in layer A above and three in layer A below) form trigonal prism around the central atom.

Hence the coordination number of hexagonal close packing crystal is 12.

For example:: Co, Mg, Zn.

#### 4. Face centred cubic(FCC) crystal or Cubic Closed packing (CCP) crystal:

Unit parameters of unit cell of this crystal are.  $a = b = c$  and  $\alpha = \beta = \gamma = 90^\circ$ .

The spheres are packed in such a way that the spheres in every second row are placed in the depressions or interstices between the spheres of the first row sphere. Each sphere or atom has six closest neighbours. If the spheres of first layer are labelled as A the spheres of second layer are labelled as B. The atoms of the third layer are placed over unoccupied voids of first layer. This gives rise to new layer labelled as C. Hence in FCC or CCP, the pattern is ABCABC ..... is

called face centred cubic or cubic close packing. Each atom in an FCC or CCP is surrounded by 12 nearest neighbours

Hence the coordination number of face centred cubic or cubic close packing crystal is 12.

Example: Aluminium (Al), Copper (Cu), Gold(Au), Silver (Ag)

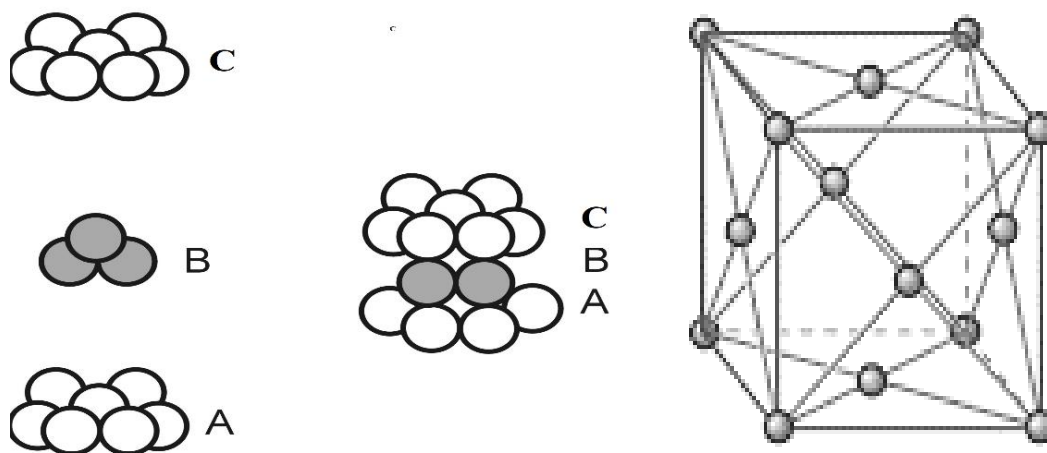

Face centred cubic close packing (ABCABC.....)

Fig. 4.27

## 4.4 Catalysis

### Significance:

There are many substances which alter the speed of chemical reaction without being used up in the reaction. J.J. Berzelius (in 1835) was the first scientist who made a systematic study of the effect of various foreign substances on the rate of chemical reaction. Such a foreign substance is called as catalyst.

The substance which alters the rate of chemical reaction without taking part in the reaction is called as catalyst. The process of altering the rate of chemical reaction by using catalyst is known as catalysis.

### 4.4.1 Type of Catalysis

A) Homogeneous catalysis      B) Heterogeneous catalysis

**A) Homogeneous catalysis:** In homogeneous catalysis reaction, catalyst and reactants are in the same phase. i.e. may be in solid, liquid or gaseous phase.

Example: Manufacturing of sulphuric acid ( $\text{H}_2\text{SO}_4$ ) by chamber process.

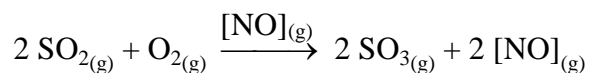

**B) Heterogeneous catalysis:** When reactants and catalysts are in different phase then this reaction is called as heterogeneous catalysis. For example: Preparation of ammonia by Haber process.

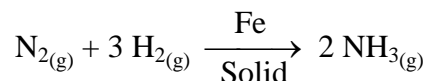

#### 4.4.2 Theories of Catalysis

**A) Adsorption theory:** This theory was postulated by Faraday in 1883. It explains the mechanism of heterogeneous catalysis.

The mechanism consists of four distinct steps:

**Step - I:** Adsorption of reactant molecules:

The reactant molecules get adsorbed on the surface of catalyst.

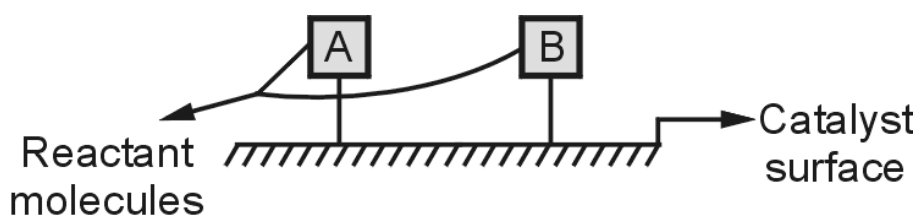

Fig.4.28

**Step - II:** The adsorbed reactant molecules combine to form intermediate complex which is less stable.

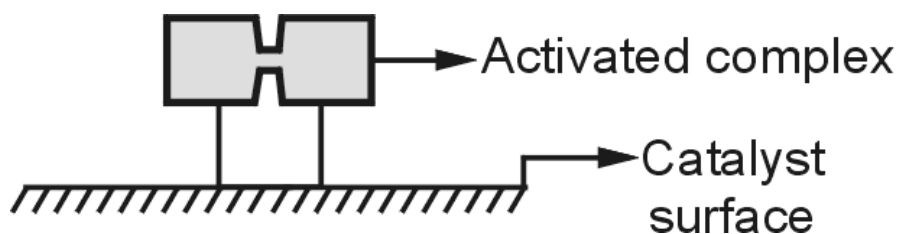

Fig.4.29

**Step - III:** The activated complex breaks to form the products C and D.

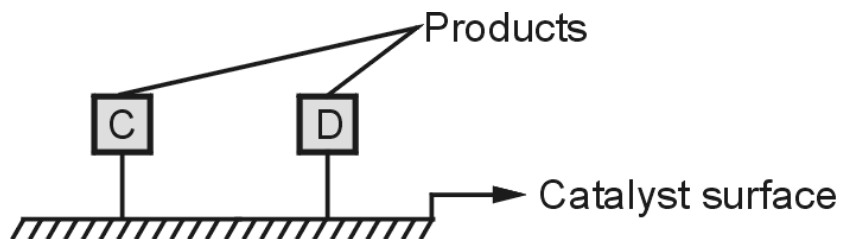

Fig. 4.30

**Step - IV:** The molecules of the product fly off; leaving the surface for fresh action which is called as desorption of products.

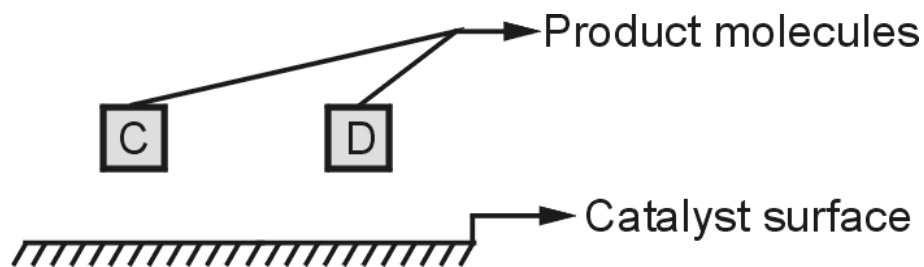

Fig. 4.31

The above mechanism clearly indicates that the substance which acts as a catalytic promoter must have more affinity for catalyst surface, so that it can be easily adsorbed on the catalyst surface.

### B) Intermediate compound formation theory:

This theory was forwarded by element and Desormsin 1806. According to this theory one of the reactant combines with catalyst and forms highly reactive intermediate compound which reacts with second reactant to obtain the product.

Let's explain this by using the general reaction:

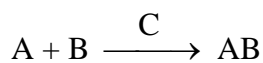

Where 'A' and 'B' are the reactants and 'C' is the catalyst. The reaction involves following steps:

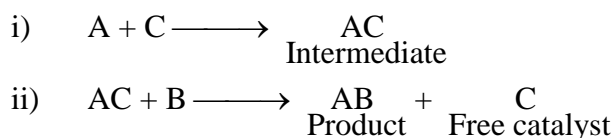

- The **adsorption theory** is applicable to heterogeneous catalysis and intermediate compound formation theory is applicable to homogeneous catalysis.

- **Characteristics of catalysts :**

- 1) To increase the rate of reaction very small quantity of catalyst should be enough.
- 2) A single catalyst cannot catalyze all the chemical reactions.
- 3) Catalyst can alter the rate of reaction but it can't stop or start the reaction.
- 4) The efficiency of a catalyst depends upon its physical state.
- 5) A catalyst remains unchanged chemically at the end of the reaction.

### 4.4.3 Types of Catalyst

#### 1) Positive Catalyst

“The substance which increases the rate of reaction, when added is called as positive catalyst”.

For example:: The presence of 1mg of fine Platinum powder is enough to catalyze, 2.5 liters of mixture of  $H_2$  and  $O_2$  to form  $H_2O$ .

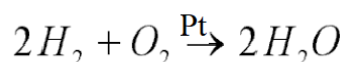

## 2) Negative Catalyst

“The substance which retards the rate of chemical reaction, when added is called as negative catalyst”.

For example:: Chloroform is used as an aesthetic. In presence of oxygen, it undergoes oxidation and forms poisonous compound Carbonyl Chloride (COCl<sub>2</sub>). When two percent of ethanol is added to chloroform, it retards the rate of oxidation reaction and acts as a negative catalyst.

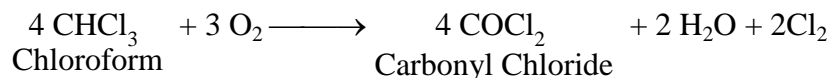

## 3) Auto Catalyst

“When one of the products of a reaction itself acts as a catalyst for that reaction, the phenomenon is called as autocatalysis. The substance which acts as a catalyst is called as auto catalyst”.

For example:: The hydrolysis of ethyl acetate forms acetic acid (CH<sub>3</sub>COOH) and ethanol. In this reaction acetic acid acts as an auto catalyst.

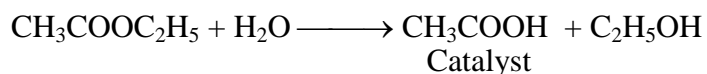

### 4.4.4 Catalytic Promoter and Catalytic Inhibitor

- **Catalytic promoter (Catalytic activator):** The substance which increases the activity of the catalyst although they themselves are not considered as catalysts are called as catalytic promoter or activators.

Example: In the Haber’s process small amount of added molybdenum (Mo) increases the activity of iron catalyst.

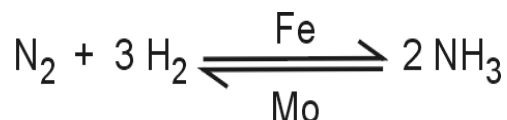

- **Catalytic inhibitor [Catalytic poison]:**

“The substance which lowers the activity of the catalyst is called as catalytic inhibitor or catalytic poison”.

Sometimes the presence of some substances destroys the efficiency of the catalyst. These are called as catalytic inhibitor.

Example: In Haber process, CO (Carbon monoxide) decreases the activity of iron catalyst.

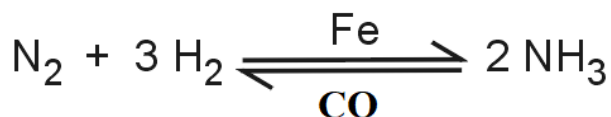

### 4.4.5 Industrial Applications of Catalyst

1) Manufacture of chlorine gas (Cl<sub>2</sub>) by Deacon’s process:







## Unit 5

### Metal Corrosion, its Prevention and Electrochemistry

**Course Outcome:** - Use corrosion preventive measures in industry.

**Unit Outcomes:** -

- 5a.** Describe phenomenon of the given type of corrosion and its prevention.
- 5b.** Identify the different factors affecting the rate of corrosion for the given type of material.
- 5c.** Select the preventive measures to prevent the corrosion in the given corrosive environment.
- 5d.** Differentiate salient features of the given electrolytic cell and electro chemical cell.
- 5e.** Distinguish the given primary and secondary electrochemical cells.
- 5f.** Describe the process of electrolysis for the given electrolyte.
- 5g.** Describe the process of electroplating of the given material

**Rationale:** -

Corrosion is the destructive attack of the environment on the materials, infrastructures like bridges, steel machineries, electric towers, oil pipe lines, ships etc. The Serious consequence of corrosion process are loss of valuable resources, plant shut down, contamination of product, reduction in efficiency, costly maintenance, expensive overdesign etc. The aim of study is to raise public awareness about corrosion and its control.

Electrochemistry is the study of chemical process that causes electrons to move. It has wide range of technological applications such as cells, batteries which are important in storing energy for mobile devices, vehicles etc. It involves production of material by electro refining, electroplating, electro deposition.

**Significance of Corrosion:**

When metals are put into use in various forms they are exposed to environment such as dry gases, moisture, liquids etc. then the exposed metal surfaces begin to decay more or less rapidly. This metallic decay is corrosion which may be due to direct chemical attack or electro chemical attack of the environment. The losses incurred due to corrosion are enormous. Hence obviously an engineer must understand the mechanism of corrosion, if its effects are to be minimized. Moreover, he will be able to avoid severe corrosion conditions and provide simultaneously protection against corrosion.

#### **5.1 Introduction**

In industry, corrosion is a serious term which leads to the destruction of the metal by surrounding environment, consisting of either gases or liquid substances. Most common example of corrosion

in day to day life is rusting of iron. Corrosion is a slow process but the resulting damage observed is tremendous and dangerous.

**Corrosion:**

**Definition:** Corrosion is defined as “Destruction of metal through chemical or electrochemical action starting from its surface”.

**5.2 Types of Corrosion**

Corrosion reactions are mainly of two types:

- 1) Atmospheric corrosion / direct chemical corrosion / Dry corrosion
- 2) Immersed corrosion / Electro-chemical corrosion / Wet corrosion

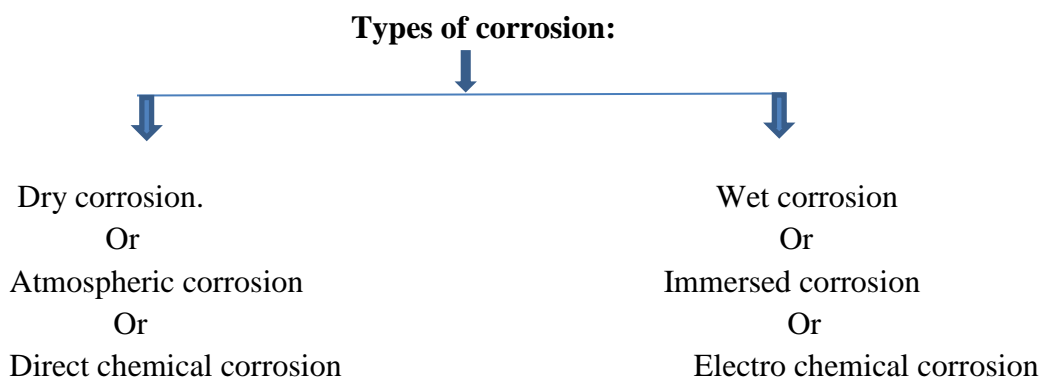

**5.2.1 Direct Chemical Corrosion / Atmospheric Corrosion**

Dry or atmospheric corrosion involves direct attack of atmospheric gases on metal surface in the absence of liquid conducting medium.

“This type of corrosion occurs when metal surface directly comes in contact with atmospheric gases like oxygen, halogen hydrogen, sulphide, carbon dioxide, etc.”

The rate of corrosion is found to be high in humid and polluted atmosphere. As atmospheric conditions are responsible for such type of corrosion, hence, it is called as ‘atmospheric corrosion’.

The atmospheric corrosion is of two types:

**1) Corrosion due to oxygen**

**2) Corrosion due to other gases**

**1) Corrosion due to the oxygen**

When metal surface comes in contact with atmospheric oxygen gas, it undergoes oxidation reaction and thin film of respective metal oxide is formed on the metal surface. Nature of oxide film decides the rate of corrosion.

This type of corrosion occurs due to direct chemical action of oxygen on metals usually in the absence of moisture.

1. When metal atoms come in contact with atmospheric oxygen, they lose electrons (oxidation) to form metal ions.
2. While the oxygen atoms accept these electrons (reduction), with formation of oxide ions.
3. These formed metal ions and oxide ions combine together due to electrostatic force of attraction to form metal oxide molecules.
4. Thus atmospheric corrosion due to oxygen results in the formation of oxide film over the metal surface.

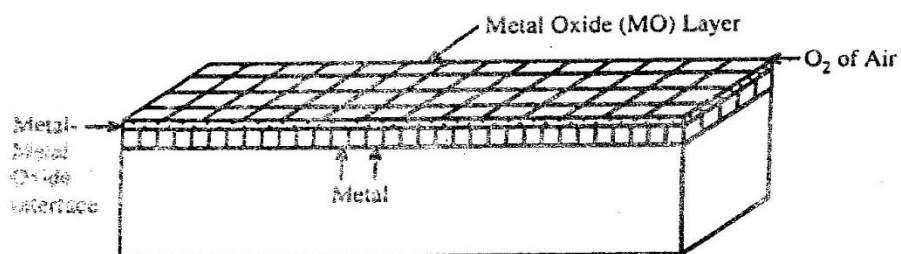

**Fig. 5.1.1**

**2) Corrosion due to other gases**

This type of corrosion occurs when metal surface comes in immediate contact directly with atmospheric gases like  $O_2$ ,  $Cl_2$ ,  $Br_2$ ,  $I_2$ ,  $H_2S$ ,  $CO_2$ ,  $SO_2$ ,  $SO_3$ ,  $NO_2$  etc. i.e. The corrosion which is brought about by the atmospheric conditions is called atmospheric corrosion.

Example-

1. Rusting of iron.
2. Formation of green film on the surface of copper.
3. Formation of black colored silver sulfide film on the surface of silver metal in the chemistry laboratory

**Types of Oxide Film**

- A) Stable oxide film
- B) Unstable oxide film
- C) Volatile oxide film

### A) Stable oxide film

This type of oxide film is stable and tightly adheres to the metal surface.

Stable oxide film is again divided into two types:

- i) Porous oxide film
- ii) Non-porous oxide film

**i) Porous oxide film (Non protective oxide film):** Alkali and alkaline earth metals on oxidation reaction produce metal oxide having smaller volume than the underlying metal. This results in the formation of porous oxide film. Due to porous nature oxygen gets penetrate through the pores and destroys the bulk metal. In this type the process of corrosion is rapid and continuous.

For example: -Such type of oxide film is formed in alkali metals like Li, K, Na and alkaline earth metals like Ca, Sr, Mg.

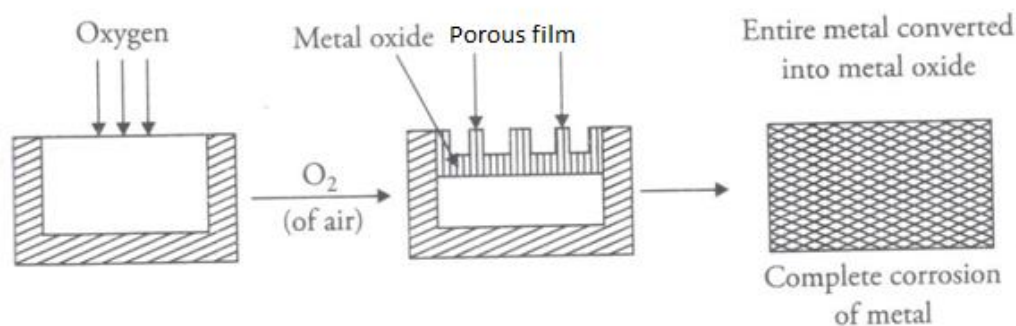

Fig 5.1.2 (a)

**ii) Non-porous oxide film (Protective oxide film):** The metal like aluminum (Al) forms oxide film having greater volume than the corresponding metal. This type of oxide film is smooth, continuous and non-porous. This non-porous oxide film acts as a protective layer and restricts further corrosion of bulk metal.

For example: Al (Aluminium), Cr (Chromium), Cu (Copper)

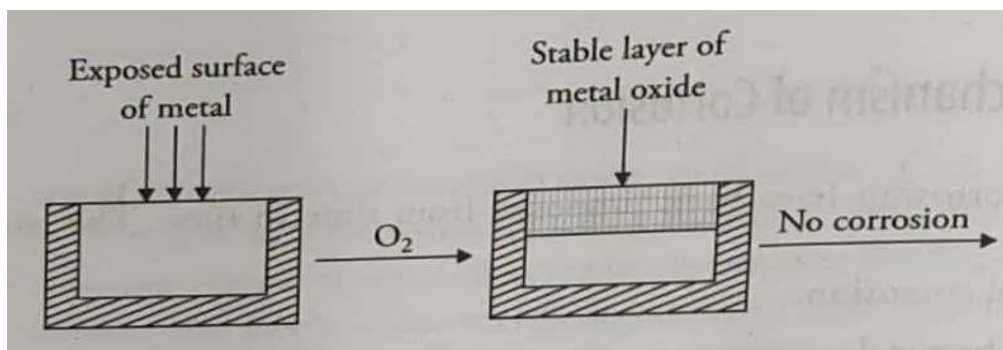
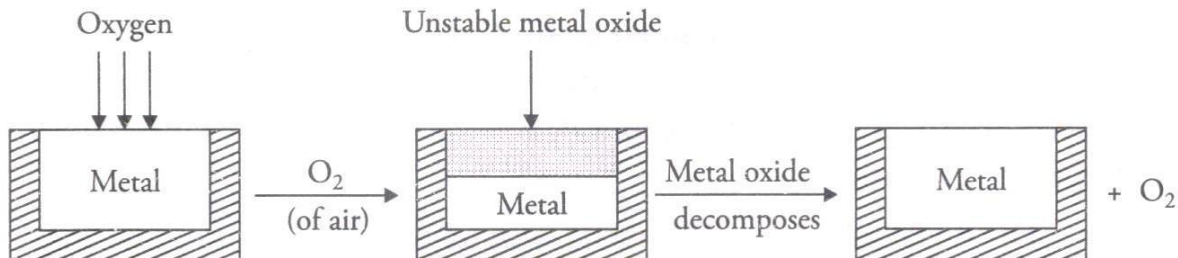

Fig 5.1.2 (b)

**B) Unstable oxide Film:** Metals like Ag, Au, Pt forms unstable oxide film on the metal surface. This type of oxide film immediately decomposes back into the metal and oxygen as soon as it forms. Hence, oxidation corrosion is not possible or zero in such case.



For Example: Such type of oxide film is formed in the noble metals like Ag, Au, and Pt.



**Fig 5.1.3**

### C) Volatile oxide film

The metal like molybdenum (Mo) when comes in contact with atmospheric oxygen gas, it forms unstable oxide film on the surface. This type of oxide film immediately vaporises leaving behind the fresh metal surface continuously. Therefore, in this type, the process of corrosion is continuous and rapid.

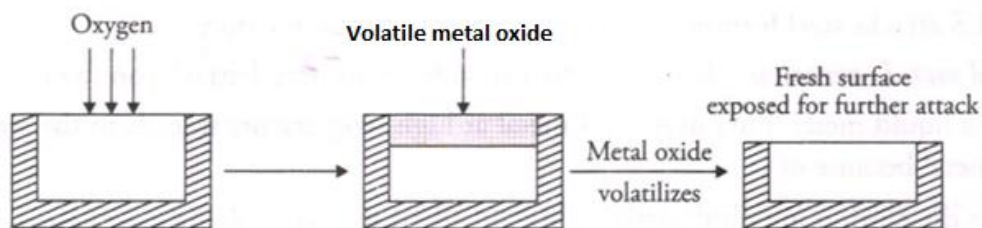

**Fig 5.1.4**

### Mechanism of Atmospheric Corrosion

Atmospheric oxygen gas is responsible for oxidation corrosion.

Mechanism of oxide film formation involves following steps:

i) When metal surface is exposed to atmospheric oxygen gas, it loses its valence electrons and undergoes oxidation reaction.



ii) Atmospheric oxygen gas accepts these electrons and undergoes reduction reaction.



Combining (a) + (b), we will get net cell reaction

Net cell reaction:

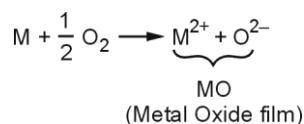

### 5.2.2 Wet Corrosion

**Definition:** “The corrosion which is brought about through ionic reactions when two dissimilar metals are in contact with each other in presence of conducting medium is called as electrochemical or immersed or wet corrosion”.

Examples:

1. Rusting of fencing wire under joints.
2. Corrosion of steel pipe connected to copper plumbing.
3. Corrosion of lead antimony solder around the copper wire.
4. Corrosion of steel screws in marine brass hardware.
5. Corrosion of iron nails which are used to join copper sheets.
6. Rusting of underground pipe line passing through dry and wet soil.

It takes place either through the formation of galvanic cell or concentration cell.

Immersed corrosion takes place by formation of following types of cell.

**a) Galvanic cells:** When two dissimilar metals are in contact with each other in presence of liquid conducting medium or moist air.

In this galvanic cell more active metal acts as anode and under goes corrosion while less active metal acts as cathode and is protected from corrosion

Examples of corrosion due to galvanic cell action.

1. Rusting of steel pipes connected to copper plumbing.
2. Rusting of iron nails used to join copper sheets
3. Rusting of steel screws in marine brass hardware
4. Rusting of lead antimony solder around the copper wire

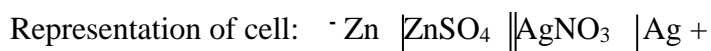

**b) Concentration cells:** When single metals is in contact with different atmospheric condition.

In differential aeration concentration cell, less oxygenated area acts as anode and undergoes corrosion while more oxygenated area becomes cathode and remains unaffected.

In metal ion concentration cell, the area of the metal in contact with the high concentration of metal ions will be protected as it acts as a cathode, and the area of metal in contact with the low metal ion concentration will be corroded as it acts as anode.

Examples of corrosion due to concentration cell action.

1. Differences in the porosity of the soil can lead to an oxygen concentration cell.
2. Uneven or rough surfaces creates oxygen concentration cell.
3. Partially buried underground pipes corrode through oxygen concentration cell.
4. Unused vehicles covered with the dust particles corrode through oxygen concentration cell.
5. Waterline corrosion
6. Pitting corrosion
7. Corrosion under drop of water.

8. Rusting of fencing wire under joints.
9. Rusting of underground pipe line passing through dry and wet soil.

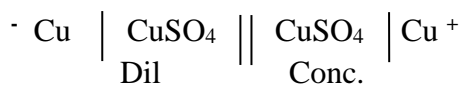
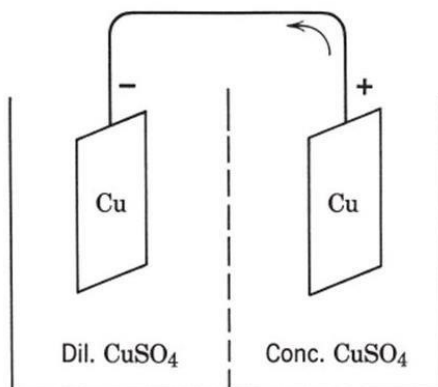

**Fig. 5.2**

### Types of Concentration cells:

#### a) Electrolyte concentration cell

The electrodes are of the same material, and the electrolyte is made up of same substance but different composition.

#### b) Electrode concentration cell

In this type the electrodes are of the same material but differ in concentration. The electrodes are dipped in the same electrolyte.

### Mechanism of wet corrosion

#### a) Hydrogen evolution mechanism [Galvanic cell action]

- i) For example, a steel tank containing acidic industrial waste with small piece of copper scrap is in contact with it.
- ii) In presence of acidic conducting medium piece of copper acts as a cathode and steel tank as anode.

Anodes undergo oxidation reaction with liberation of electrons.

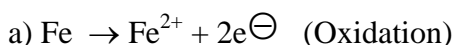

- iii) Liberated electrons flow from anode to cathode through metal. Hydrogen ions ( $\text{H}^+$ ) from electrolyte accept these liberated electrons and undergo reduction reaction with liberation of hydrogen gas.

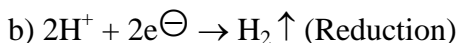

The net reaction is

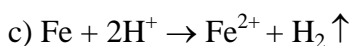

- iv) In this type of corrosion cathodic area is small and anodic area is large.

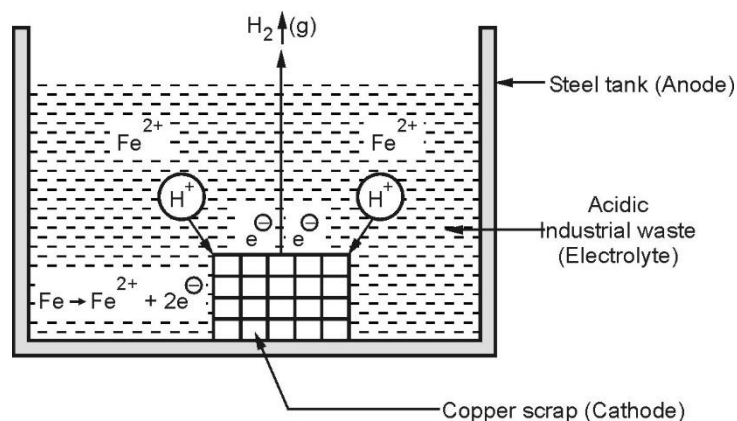

**Fig. 5.2.1 Hydrogen liberation mechanism**

**b) Oxygen absorption mechanism (Concentration cell action)**

- i) For example, rusting of iron in neutral aqueous solution in presence of atmospheric oxygen, when a drop of water is resting on an iron or steel surface.
- ii) Usually iron surface is coated with a thin film of iron oxide. If the film develops a crack, in presence of water drop or moist atmosphere developed crack acts as an anode and remaining iron oxide film acts as cathode.
- iii) The surface metal atom of anode (Fe) undergoes oxidation with liberation of electrons



Water droplet accepts liberated electrons and undergoes reduction.

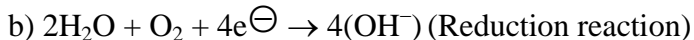

$\text{Fe}^{2+}$  ions and  $\text{OH}^{-}$  ions combine to form ferrous hydroxide.

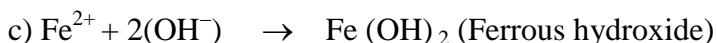

- d) In presence of sufficient quantity of oxygen ferrous hydroxide undergoes further oxidation to form ferric hydroxide, followed by decomposition to get ferric oxide, which is called as yellow rust.

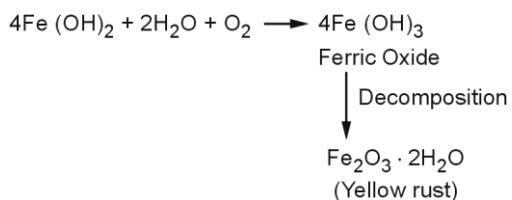

In this type cathodic area is large and anodic area is small.



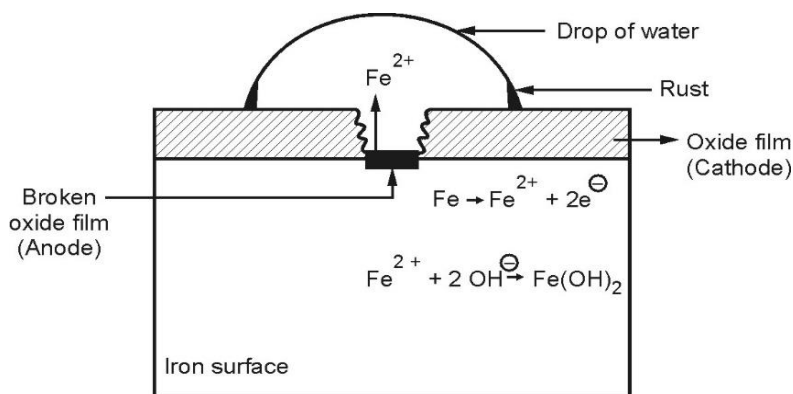

**Fig. 5.2.2 Oxygen absorption mechanism**

### 5.2.3 Pitting Corrosion

Pitting corrosion occurs due to heterogeneity in the metallic surface in presence of corroding environment. Crack developed on a protective surface film on a metal in presence of an appropriate environmental condition leads to form holes or pits. i.e. pitting corrosion is a localized attack resulting in the formation of holes on metal surface.

A pure and homogeneous metal with smooth surface will be more resistant to pitting than with defects and a rough surface. Surface cleanliness and selection of proper material can resist the pitting corrosion.

It is observed that specimens having polished surface display a greater resistant to pitting corrosion. Stainless steel alloying with about 2 % molybdenum enhances the resistivity towards pitting corrosion.

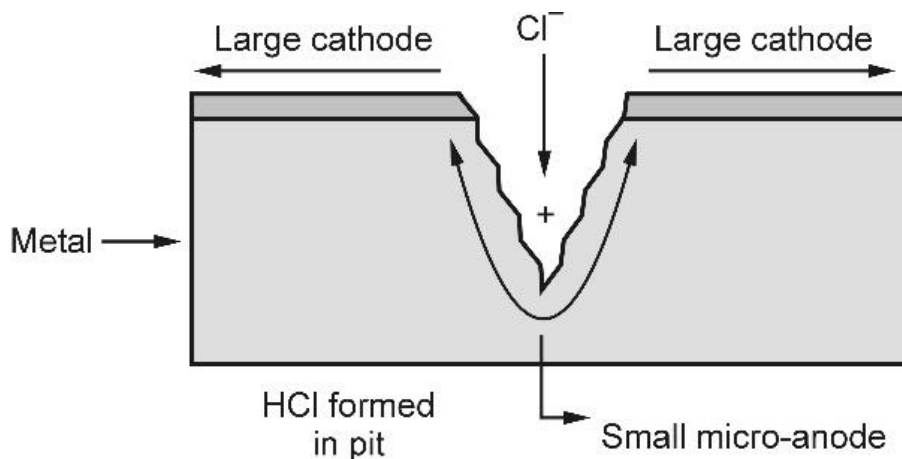

**Fig. 5.2.3 : Pitting corrosion**

### 5.2.4 Water-Line Corrosion

Differential aeration leads to the formation of oxygen concentration cell causing water-line corrosion. When water is stagnant for long time in a steel tank, it is observed that corrosion takes place just below the water level.

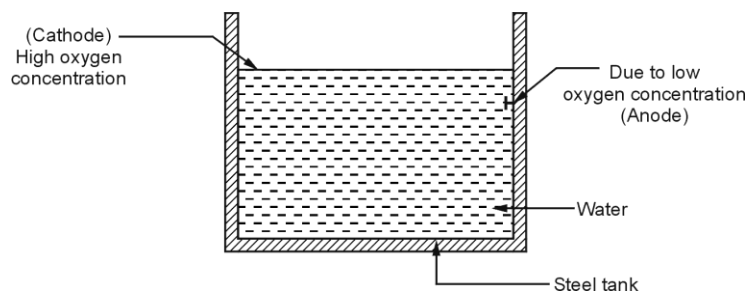

**Fig. 5.2.4 Water line corrosion**

The concentration of dissolved oxygen in surface water is high as compared to water under surface. This leads to the formation of oxygen concentration cell in which surface water acts as a cathode and water below the surface acts as anode. Hence, the metal below the water level gets corroded.

### 5.2.5 Crevice Corrosion

Crevice corrosion is an example of local corrosion. This type of corrosion occurs due to the dirt deposits, crack developed on paint coatings etc., which is commonly observed near the gaskets, bolts and rivets. Lack of oxygen in the crevice, leads to this type of corrosion.

Selection of proper material, proper design to minimize crevices and cleanliness are the measures taken to control crevice corrosion.

It can be also prevented by using welded instead of bolted joints and using non absorbing gaskets.

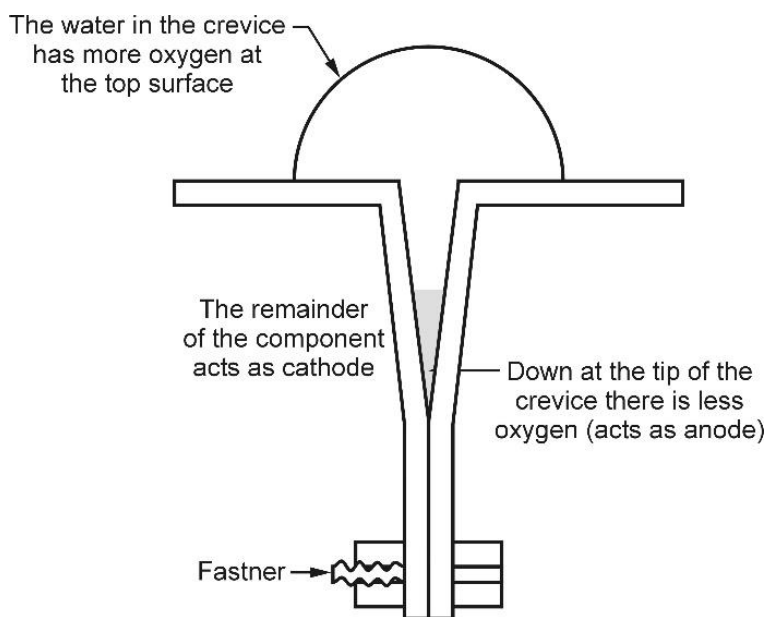

**Fig. 5.2.5 Crevice corrosion**

## 5.3 Factors Affecting the Corrosion

### A) Factors affecting the atmospheric corrosion

**i) Impurities in the atmosphere:** Normal atmosphere contains oxygen (20%), nitrogen (78%) with small amount of  $\text{CO}_2$ ,  $\text{H}_2\text{O}$  and rare gases. But due to industrialization atmosphere contains

pollutant like  $\text{CO}_2$ ,  $\text{Cl}_2$ ,  $\text{H}_2\text{S}$ ,  $\text{SO}_2$ , which readily attacks the metal forming corresponding compounds like carbonates, chlorides, sulphides, sulphates etc. along with oxides, i.e. Corrosion rate is fast in the presence of all impurities such as  $\text{H}_2\text{S}$ ,  $\text{SO}_2$ ,  $\text{CO}_2$ ,  $\text{Cl}_2$ , along with vapours of  $\text{HCl}$  and  $\text{H}_2\text{SO}_4$  etc. Atmospheric air near industrial areas contains these impurities.

**ii) Humidity:** The rate of corrosion is found to be high in humid atmosphere. The main reason for increased corrosion rate in humid atmosphere is that gases present in atmosphere dissolve in moisture which enhances the chemical and electrochemical reactions on the metallic surfaces leading to the corrosion.

The extent of attack depends on the nature, properties and position of metal in galvanic series.

**iii) Temperature:** The rate of corrosion increases with increase in temperature. Higher the temperature, greater is the rate of corrosion. A passive metal becomes active at high temperature. Type of intergranular corrosion such as caustic embrittlement takes place in high pressure boilers only at high temperature.

**iv) Effect of PH:** - In general acidic media are more corrosive than alkaline and neutral media.

**v) Differential aeration:** Increase in concentration of oxygen in one part of the metal gives rise to oxygen concentration cell in which corrosion occurs where oxygen access is least.

## **B) Factors affecting immersed / wet corrosion**

**i) Purity of the metal:** Pure metal resists the process of corrosion. Hence, in case of 100 % pure metal, rate of corrosion is found to be low.

The impurity present in a metal forms the number of tiny galvanic cells as a result of which the anodic part gets corroded. The rate of corrosion increases with the increasing exposure of the impurities. Thus corrosion resistance of metal can be improved by increasing its purity.

**ii) Nature of the oxide film:** The nature of oxide film highly affects the rate of corrosion.

In case of unstable oxide film almost zero corrosion is observed. The rate of corrosion is found to be maximum in case of volatile oxide film. Non-porous oxide film acts as a barrier and protects the bulk metal from further corrosion. The metal like iron forms porous oxide film, where high rate of corrosion is observed.

**iii) Solubility of the corrosion product:** If the corrosion product is insoluble in corroding medium then it acts as a barrier and restricts further corrosion of the metal. But if the corrosion product is soluble in corroding medium then due to continuous exposure of fresh metal to the corroding medium, corrosion process is continuous and rapid.

**iv) Position of metal in galvanic series:** Metals having higher position in galvanic series have high oxidation potential and get corroded easily.

Metals having low position in galvanic series have high reduction potential and low oxidation potential hence they have less tendency to get corroded.

**v) Effect of  $\text{p}^{\text{H}}$ :** One of the most important factors in corrosion reaction is concentration of hydrogen ion. Acidic media is more corrosive than alkaline and neutral media. Many metals are resistant to alkali although they are readily attacked by acids.

The rate of corrosion is directly proportional to the hydrogen ion concentration.

## 5.4 Corrosion Control

- A) Modification of the environment
- B) Use of protective coatings
- I) Use of less active metal for coating (Tinning).
- II) Use of more active metal for coating (Galvanizing)
- C) Anodic and cathodic protection
- D) Choice of material – Using pure metal and using metal alloys.

**A) Modification of the environment:** The corrosion of the metal can be reduced by modifying the environment by using following ways:

- I) Removal of harmful corrosion stimulants
- II) Use of corrosion inhibitors

### **I) Removal of harmful corrosion stimulants:**

- 1) **Alkaline neutralization:** Prevention of corrosion because of acidic environment is done by using neutralizers like  $\text{NH}_3$ , lime etc. in vapour or liquid form.
- 2) **Dehumidification:** Moisture or humidity in atmosphere is one of the important factor which is responsible for corrosion. Dehumidification is done by using silica gel to prevent corrosion due to moisture.

### **II) Use of corrosion inhibitors:**

Inhibitors are the organic or inorganic substances, which when added in small quantity to the corrosive environment, effectively minimises the corrosion of metal.

Inhibitor forms the physical barrier between the metal and the corroding medium and protects the metal from corrosion.

Corrosion inhibitors are of following types:

- 1) Anodic inhibitors: For example: Phosphates, Chromates
- 2) Cathodic inhibitors: For example: Amines, Urea
- 3) Vapour phase inhibitors: For example: Dichlorohexylammonium nitrate

### **B) Use of protective coatings**

- I) Use of less active metal for coating (Tinning)**
- II) Use of more active metal for coating (Galvanizing)**
- I) Use of less active metal (Tinning)**

In this process tin is used as a coating metal. “Tinning is the process of coating steel sheets with a thin and uniform coat of tin to prevent it from corrosion”.

Tin is a low melting metal (M.P-232 °C), less electropositive than iron, nobler and therefore, it is more resistant to chemical attack.

### **Process**

- To remove oxide film and impurities present on the surface of steel sheet, it is cleaned by dilute sulphuric acid.
- Cleaned sheet is passed through a bath containing molten flux of zinc chloride which helps the molten metal to get adhered to the sheet.

- The steel sheet is then passed through a tank of molten tin followed by palm oil to prevent oxidation of hot tin coated surface.
- To remove excess of tin and to get uniform coating the sheet is passed through a series of hot rollers.
- The operating temperature for tinning process is 250 - 290 °C

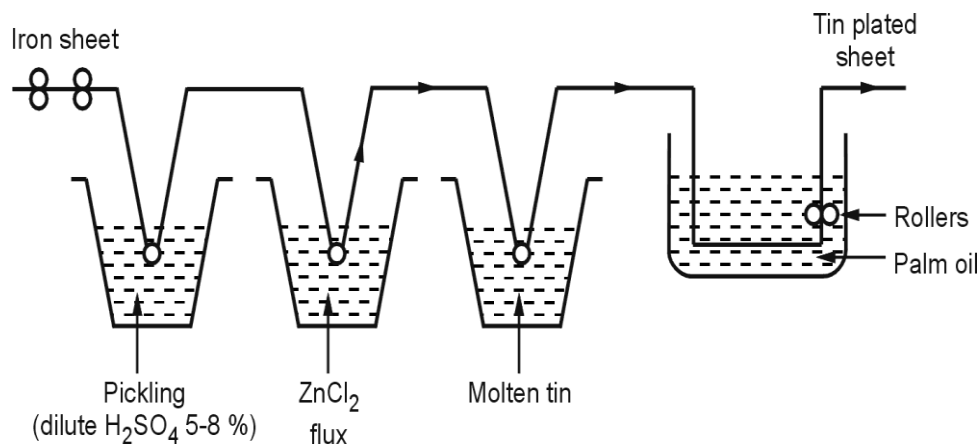

**Fig. 5.4.1 Process of tinning**

**Advantages:**

- Tin is extensively used for coating steel containers which are used to store foodstuffs as tin is resistant to action of organic acids (less active) and water, avoids food poisoning.
- Improves corrosion resistance/prevents rusting of base metal.

**Disadvantages:**

- Tin protects the metal till the coating is intact, crack or damage in coating causes rapid corrosion.

**Applications:**

Aerospace, automotive, coinage, food service, electrical and electronics, telecommunications, medical, energy and jewellery.

**II) Use of more active metal coating (Galvanizing)**

“The process of coating iron or steel sheet with a thin coat of zinc by hot dipping process to prevent corrosion is called as galvanizing”.

**Process**

- The iron sheet to be galvanized is first cleaned with sulphuric acid, then washed in washing bath and then dried in drying chamber.
- Cleaned iron sheet is then dipped in the bath of molten zinc at 425 - 460 °C which is covered with NH<sub>4</sub>Cl flux to prevent atmospheric oxidation.
- To remove excess of zinc, coated sheet is passed through a pair of rollers where uniform coating of zinc is obtained.
- Coated sheet is finally annealed at 650 °C temperature and then slowly cooled.

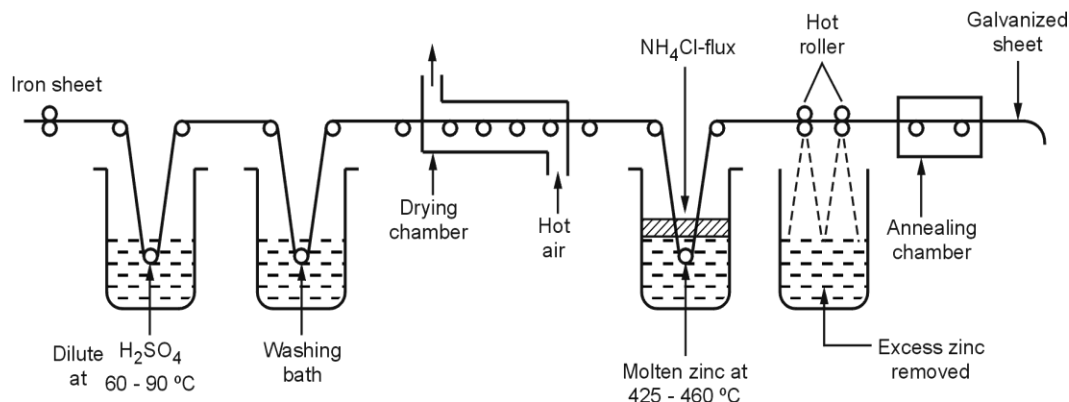

**Fig. 5.4.2 Process of galvanizing**

**Advantages:**

- Even when the protective zinc coating is broken, iron is protected because zinc is more electropositive than iron and therefore does not allow iron to pass into the solution.
- Zinc protects the metal till the coating is intact, crack or damage in coating protects the base metal from corrosion as zinc is more active than base metal.

**Disadvantages:**

- Galvanized containers are not used to store foodstuffs because zinc gets dissolved in dilute acids forming hazardous zinc compounds which are harmful to health.

**Applications:**

1. Galvanized steel frames and roof tops for construction.
2. To galvanize door frames, window frames, bars, house-hold items such as buckets, tubs and other containers.
3. To galvanize machine parts, tools, ships, tanks and wires.
4. Metal pipes and wires are most popular galvanized items which find application in industrial use as well as in articles made for domestic use.
5. Protective gears, highway signs, high tension electric towers.

**Differentiate between galvanizing and tinning**

**Table 5.1**

Sr. No.	Galvanizing	Tinning
1)	It is the process of coating iron sheet with a thin coat of zinc to prevent corrosion.	It is the process of coating mild steel sheet with thin coat of tin to prevent corrosion.
2)	Galvanized containers are not used to store food stuffs.	Tinned containers are used to store food stuffs.
3)	Zinc protects the metal continuously by galvanic cell action.	Tin protects the metal till the coating is intact, crack or damage in coating causes rapid corrosion.

4)	In galvanizing zinc protects the metal because it is more electropositive than iron.	Tin protects base metal from corrosion because it is less electropositive than iron.
----	--	--

### C) Anodic and Cathodic Protection

#### i) Anodic protection:

The prevention of corrosion by using impressed anodic current method is called as anodic protection. Metals like Chromium (Cr), Titanium (Ti) and alloys like steel can be made passive by the application of controlled anodic current as they form protective oxide film on their surface which leads to decrease the corrosion rate.

- To protect a structure anodically, a device called as a 'Potentiostat' is used. Potentiostat is an electronic device which maintains metal at constant potential with respect to reference electrode.
- A potentiostat has three terminals, one is connected to the tank or structure to be protected, second terminal is connected to the auxiliary cathode and third terminal is connected to the reference electrode.

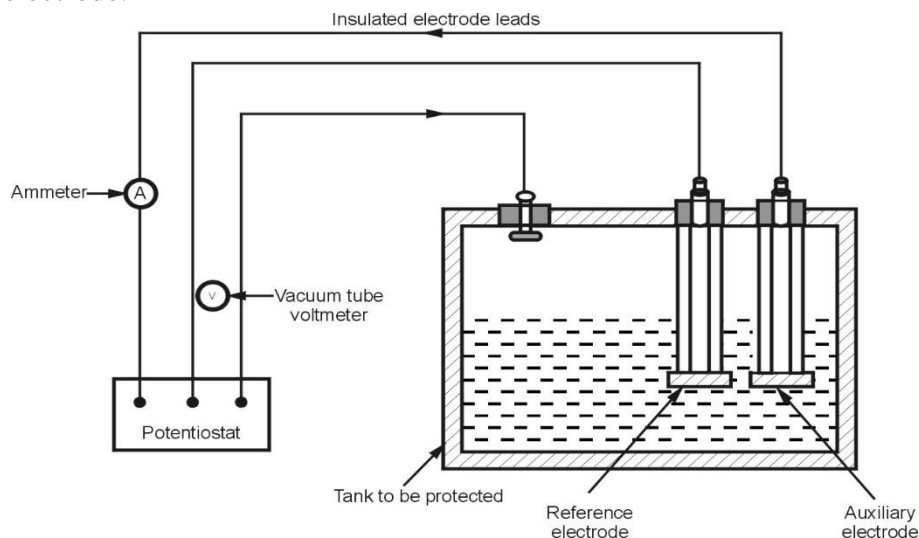

**Fig. 5.4.3 Anodic protection system**

- Actually, the potentiostat maintains a constant potential between the structure to be protected and the reference electrode, resulting to decrease in corrosion rate.

#### Advantages:

- 1) Current requirement is low and applicable in extremely corrosive environment.
- 2) Low operating cost.

#### Disadvantages:

- 1) High installation cost is required for reference electrode, auxiliary electrode and potentiostat.
- 2) Suitable for only those metal-corrodent systems which show active-passive behaviour.

**ii) Cathodic protection** – It can be done by supplying electrons to the metal structure to be protected.

#### Types of cathodic protection:

##### a) Sacrificial anodic protection (galvanic protection)

- In this method, the article to be protected is connected to more active metal, more active metal behaves as an anode and undergo corrosion leaving behind our article protected.

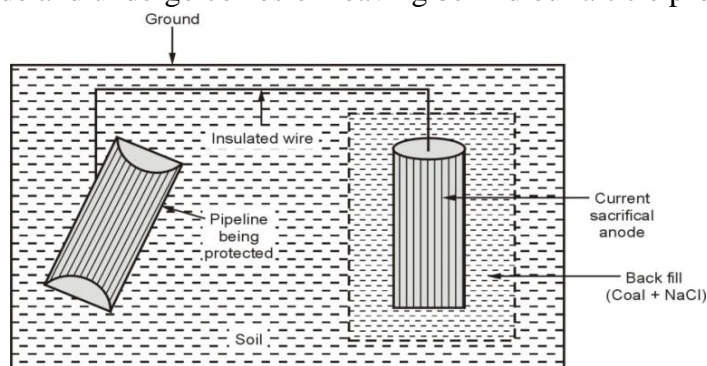

Fig. 2.4.4

**Fig. 5.4.4 (a) Using sacrificial anode**

- The article to be protected is connected to more active metal by using insulating wire. It is called as 'Sacrificial anode'. To increase electrical contact sacrificial anode is kept in back fill (Coal + NaCl).
- Metals commonly used as sacrificial anodes are Mg, Zn, Al and their alloys.
- When the sacrificial anode is consumed completely, it is replaced by fresh piece.

**Applications:**

- Protection as buried pipelines, hot water tank, underground cables from soil corrosion.
- Protection from marine corrosion of cables, ship hulls, piers etc.
- Insertion of magnesium sheets into the domestic water boilers to prevent the formation of rust.

**Advantages:**

- 1) Low installation and operating cost.
- 2) Capacity to protect complex structures.

**Limitations:**

- High starting current is required.
- Uncoated parts cannot be protected

**b) Impressed current cathodic protection**

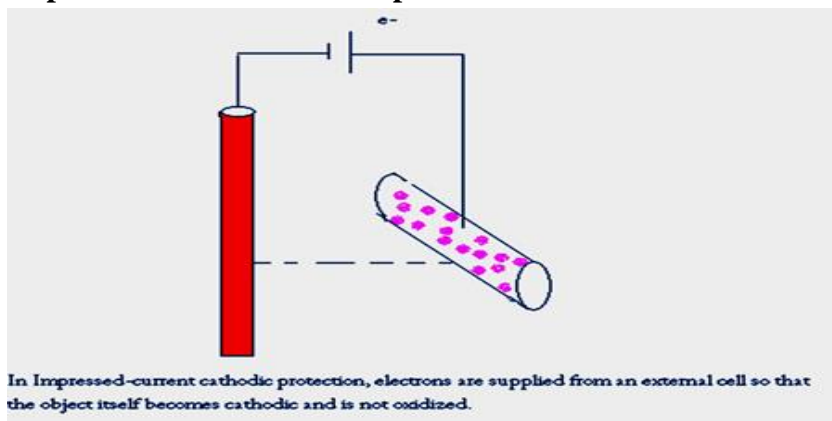

**Fig. 5.4.4 (a) Using impressed current**



- In this method, an impressed current is applied in opposite direction to nullify the corrosion current and convert the corroding metal from anode to cathode.
- Usually the impressed current is derived from a direct current sources (like battery or rectifier on AC line) with an inert anode (like graphite, scrap iron, stainless steel, platinum or high silica iron).
- A sufficient DC current is applied to an inert anode, buried in the soil (or immersed in the corroding medium) and connected to the metallic structure to be protected. The anode is usually kept in back fill, composed of coke breeze or gypsum, to increase the electrical contact with the surrounding soil.

**Applications:**

- Impressed current cathodic protection has been applied to open water box coolers, water tanks, buried oil or water pipes, condensers, transmission line towers, marine piers, laid up ships etc.
- This kind of protection technique is particularly useful for large structures for long term operations.

**D) Choice of material: Using pure metal and using metal alloys**

Selection of the right type of material is the main factor for corrosion control.

- **Using pure metal:** Noble or inert metals are most immune to corrosion but they cannot be used for general purposes as they are very costly. The next option is to use the purest possible metal, which is done by using refining process. Pure metal resists the process of corrosion, refining process is used to get extra pure metal and to minimise corrosion.

**Using metal alloys:** The metals can be made corrosion resistant by alloying them with suitable alloying elements. eg. Steel becomes resistant to corrosion on addition of Cr, Ni, elements.

## 5.5 Electrochemistry

**Significance:**

Electrical energy plays an important role in many chemical reactions. Electrochemistry is a branch of science which deals with the production of electricity from energy released during spontaneous chemical reaction and the use of electrical energy to bring about non- spontaneous chemical reactions. Such changes are called electrical changes and find use in the manufacturing of cells and batteries used in various instruments and devices which generates electricity due to chemical changes.

A large number of metals, sodium hydroxide, chlorine gas and many other chemicals are produced by electrochemical methods. The reactions carried out electrochemically are less polluting.

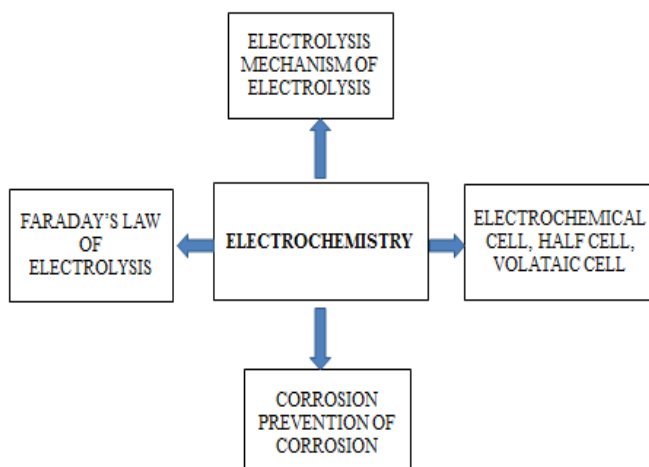

**Fig. 5.5.1**

### **5.6. Important Terms and their Definitions Used in Electrochemistry:**

**Conductor:** It is a substance which allows the electric current to pass through it. Ex: - All metals, graphite, fused (molten) salts, aqueous solution of acids, bases, salts

**Insulator:** It is a substance which does not allow the electric current to pass through it. Ex:-wood, paper, plastic, alcohol etc.

#### **Types of conductors:**

Conductors are classified into two types:

- 1. Metallic conductor:** These are the metallic substances which conduct electricity through them without undergoing any chemical changes. Metals and their alloys carry electric current due to the flow of electrons in the metal atoms. Ex: - Metals like copper, aluminium silver etc.
- 2. Electrolytic conductor or Electrolyte:** These are the substance which in fused state or in aqueous solution liberate ions and allow electric current to pass through it resulting in chemical decomposition. In this type of conductors, charge is carried by ions. i.e Conduction will not occur unless the ions are free to move. Therefore, these substances do not carry electric current in solid state but conduct in molten state or their aqueous solution due to movement of ions. For example: acids, bases & salts.

**Differences between metallic & electrolytic conductor****Table 5.2**

Sr.No.	Metallic conductor	Electrolytic conductor
1.	These are the substances which conduct electricity due to the flow of electrons. Ex: - all metals.	These are the substance which in fused state or in aqueous solution liberates ions & allows electric current to pass through it resulting in chemical decomposition Ex: - acids, bases & salts.
2.	It does not involve any transfer of matter.	It involves transfer of matter.
3.	It shows the decreases in conductance (increase in resistance) as the temperature increases.	It shows the increases in conductance as the temperature increases.



**Definition:** The substances which conduct electricity in molten state or in aqueous solution and undergo chemical changes are called as electrolyte.

Electrolytes are of following types:

- **Strong electrolytes:** Electrolytes which are highly ionised in solution or in fused state, hence having high degree of ionisation are called as strong electrolytes.  
For example: - Strong acids like HCl, H<sub>2</sub>SO<sub>4</sub>, HNO<sub>3</sub>, strong bases like NaOH, KOH & almost all soluble salts. CuSO<sub>4</sub>, NaCl etc.
- **Weak electrolyte:** The substance which ionizes to a small extent in fused state or in aqueous solution hence having low degree of ionisation are called as weak electrolytes.  
For example: Weak acids like carbonic acid(H<sub>2</sub>CO<sub>3</sub>), acetic acid(CH<sub>3</sub>COOH), Oxalic acid(C<sub>2</sub>O<sub>4</sub>H<sub>2</sub>), Boric acid(H<sub>3</sub>BO<sub>3</sub>) and weak bases like NH<sub>4</sub>OH, Ca(OH)<sub>2</sub> & salts like BaSO<sub>4</sub>, Al(OH)<sub>3</sub> etc.
- **Non electrolyte:** The substances which cannot conduct electricity either in molten state or in aqueous solution are called as non-electrolytes.  
For example: Oils, CCl<sub>4</sub>, alcohol, sugar, petrol etc.

The extent of weak electrolyte is expressed in terms of degree of ionization or degree of dissociation.

**Degree of ionization.**

The degree of ionization is defined as the fraction of total number of molecules of an electrolytes that get ionized in solution.

$$\text{Degree of ionization} = \frac{\text{Number of molecules present as ions}}{\text{Total number of molecules dissolved in solution}}$$

For strong electrolyte, degree of ionization is equal to 1 and for weak electrolyte; it is always less than 1.

The factors affecting degree of ionization are:

- A) Nature of solute
- B) Nature of solvent
- C) Concentration of solution
- D) Temperature

A) Nature of solute: Strong acids like HCl, H<sub>2</sub>SO<sub>4</sub>, HNO<sub>3</sub>, Strong bases like NaOH, KOH & almost all soluble salts. CuSO<sub>4</sub>, NaCl etc. have high degree of ionization.

Weak acids like H<sub>2</sub>CO<sub>3</sub>, CH<sub>3</sub>COOH, (COOH)<sub>2</sub>, Weak bases like NH<sub>4</sub>OH, Ca(OH)<sub>2</sub> & salts like BaSO<sub>4</sub>, Al(OH)<sub>3</sub> etc. have less degree of ionization.

B) Nature of solvent: Polar solvent reduces electrostatic force of attraction between cation & anion. Hence in polar solvents like water the degree of ionization is more. In non-polar solvents like benzene, carbon tetra chloride the degree of ionization is less.

C) Concentration of solution: As quantity of polar solvent like water increases, the degree of ionization increases. Hence degree of ionization is inversely proportional to concentration of solution. i.e. Concentration of solution increases, the degree of ionization decreases.

D) Temperature: As the temperature increases, molecule moves with high speed, hence molecular velocity increases which overcome electrostatic force of attraction between cation & anion & molecule ionizes. Therefore the degree of ionization increases.

### Distinguish between strong and weak electrolytes

**Table 5.3**

Sr. No.	Strong electrolytes	Weak electrolytes
1)	Strong electrolytes undergo complete ionization in fused state or in aqueous solution.	Weak electrolytes undergo ionization to small extent in molten state or in aqueous solution.
2)	They are good conductors of electricity.	They are weak conductor of electricity.
3)	They have high degree of ionisation.	They have low degree of ionisation.
4)	eg : HCl, NaOH, NaCl	eg : CH <sub>3</sub> COOH, NH <sub>4</sub> OH

### c) Electrolytic cell and electrochemical cell

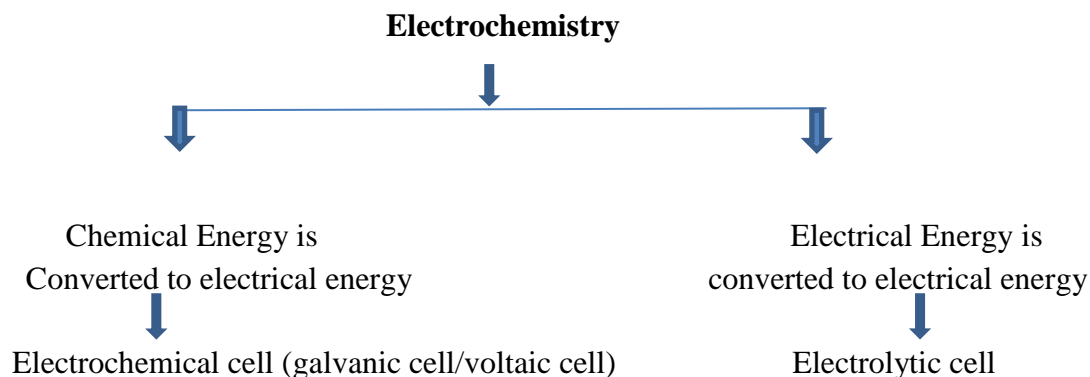

- **Electrolytic cell:** The device which converts electrical energy into chemical energy, i.e. non-spontaneous chemical reaction is carried out using electrical energy is called as electrolytic cell.

For example: Electroplating, electro-typing, electro-refining, electrolysis.

- **Electrochemical cell:** The device which converts chemical energy into electrical energy by means of spontaneous chemical reaction is called as electrochemical cell.

For example: Dry cell or Leclanche cell, Daniel cell, Lead acid storage battery cell, Nickel cadmium.

### Distinguish between electrochemical and electrolytic cell

**Table 5.4**

Sr. No.	Electrochemical cell	Electrolytic cell
1)	It is a device which converts chemical energy into electrical energy.	It is a device which converts electrical energy into chemical energy.
2)	Spontaneous chemical reaction is used to generate electricity.	Non-spontaneous chemical reaction is carried out by using electric current.
3)	In this, cathode is the positive terminal and anode is the negative terminal of the battery.	In this, cathode is the negative terminal and anode is the positive terminal of the battery.
4)	For example: Galvanic cell, Daniel cell	For example: Electroplating, Electrolysis of $\text{CuSO}_4$ .

### c) Cathode and Anode

In order to pass the electric current through the electrolytes two rods or plates are always needed which are connected to the terminals of a battery. These rods or plates are known as electrodes. The electrode through which the current enters the electrolyte is called as anode (positive electrode). While the electrode through which the current leaves the electrolyte is known as cathode (negative electrode).

The electrolyte conducts the electricity not by virtue of flow of electrons as in metallic conductors but as a result of movement of charged particles called ions towards the respective oppositely charged electrode. The ions which carry positive charge and move towards cathode are termed as cations while the ions which carry negative charge and move towards anode are termed as anions.

When these ions reach the boundary between a metallic and an electrolyte, electrons are being either attached or removed from the ions. Removal of electrons is termed as oxidation (de-electronation) which occurs at anode and addition of electrons is termed as reduction (electronation) which occurs at cathode. Hence the flow of electrons through the outer circuit from anode to cathode across the boundary is accompanied by oxidation and reduction.

**Cathode:** The electrode where reduction occurs. i.e. where electrons are accepted.

**Anode:** The electrode where oxidation occurs. i.e. where electrons are lost.

In case of electrolytic cell, Cathode is the electrode which is connected to negative terminal of the battery whereas Anode is the electrode which is connected to the positive terminal of the battery. When an electric current is passing, there is a flow of electrons from negative terminal of battery to the cathode and from anode to positive terminal of battery.

### Distinguish between Cathode and Anode

Table 5.5

Sr. No.	Cathode	Anode
1)	It is negative electrode, connected to the negative terminal of the battery when electric current is passed through an electrolyte.	It is connected to the positive terminal of the battery when electric current is passed through an electrolyte.
2)	Spontaneously it takes part in reduction reaction.	Spontaneously oxidation reaction occurs at anode.
3)	During electrolysis, flow of electrons is from negative terminal to the cathode.	During electrolysis, flow of electrons is from anode to the positive terminal of the battery.

### d) Electrode potential - Oxidation and Reduction

When metal rod is immersed in its own salt solution then there are two possibilities:

- **Possibility I:** The metal atoms present on the surface of the metal rod have a tendency to pass into the solution leaving behind an equivalent number of electrons on the surface of metal rod. Thus the metal rod acquires negative charge [Fig. 2.6.1(a)]. This reaction is called as oxidation or de-electronation.



For example: Zn rod immersed in ZnSO<sub>4</sub> solution (Fig. 5.6.1 a).

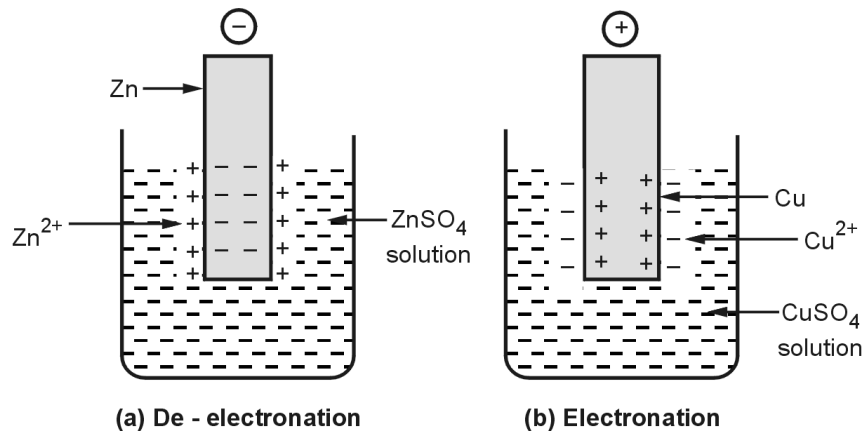
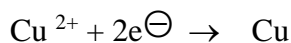

Fig. 5.6.1

- **Possibility II:** The positive metal ions present in the solution have a tendency to accept electrons from the metal rod and get deposit on it as metal atoms. Thus metal rod acquires positive charge [Fig. 5.6.1(b)]. The reaction is called as reduction or electronation.



For example: Cu rod immersed in CuSO<sub>4</sub> solution (Fig. 5.6.1 b).



Thus an electrical double layer is formed at the junction. It creates a potential difference between the metal and the solution. This potential difference leads to the development of the electrode potential.

**Electrode Potential:** “Electrode potential of a metal is the measure of tendency of metallic electrode to lose or gain electrons, when it is immersed in its own salt solution”.

- **Oxidation potential:** “The tendency of an electrode to lose electrons is a direct measure of its tendency to get oxidised and is called as oxidation potential”.

For example: Zinc (Zn) rod in ZnSO<sub>4</sub> solution.

- **Reduction potential:** “The tendency of an electrode to gain or accept electrons is a direct measure of its tendency to get reduced and is called as reduction potential.

For example: Copper (Cu) rod in CuSO<sub>4</sub> solution.

#### e) Ionization and Dissociation

- **Ionization:** “Ionization is the process of breaking up of a substance into charged atoms or radicals”.
- **Dissociation:** “Dissociation is the process of breaking up of electrovalent compound into ions when dissolved in water”.

#### f) Primary and Secondary cell

- **Primary cells:** Primary cells are the cells which convert chemical energy into electrical energy till the chemical components are active, once the active chemical components are used up, they cannot be recharged or reused”.

For example: Dry cell or Leclanche cell, Daniel cell.

- **Secondary cell:** These are rechargeable cells, the redox reaction converts chemical energy into electrical energy which can be reversed by passage of electric current. The electrical energy is stored in the form of chemical energy hence they are also called as storage cells. During discharge these cells behave as galvanic/electrochemical cell and during recharge as electrolytic cell.

For example: Lead acid storage battery, Ni-Cd battery.

**Distinguish between primary and secondary cells****Table 5.6**

Sr. No.	Primary cell	Secondary cell
1)	Primary cells are non-rechargeable cells.	Secondary cells are rechargeable cells.
2)	The cell reaction is irreversible.	The cell reaction is reversible.
3)	Once the active components are used up, they cannot be reused.	Electrical energy is stored in the form of chemical energy hence they are also called as storage cells.
4)	They have short life.	They have long life.
5)	Its cost is low.	Its cost is high.
6)	For example: Dry cell	For example: Ni-Cd cell

**5.7 Construction and Working of Daniel Cell****(a) Daniel cell with porous partition:**

- The most common example of electrochemical or galvanic cell is Daniel cell. It consists of a zinc electrode immersed in zinc sulphate solution and copper electrode immersed in copper sulphate solution. Both the electrolytes  $ZnSO_4$  and  $CuSO_4$  are separated by porous partition.

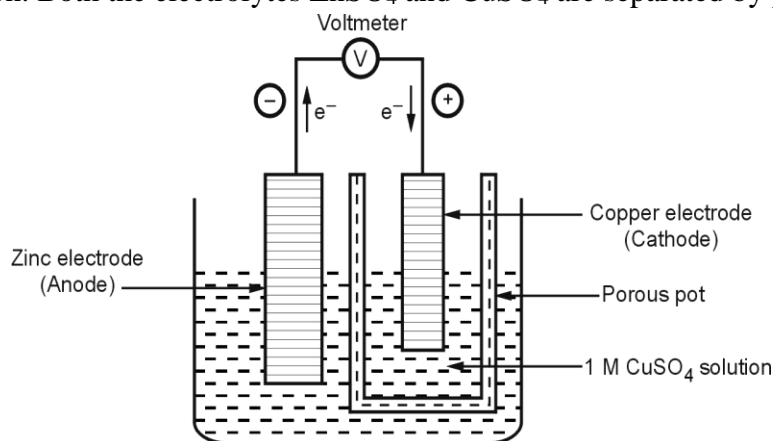
**Fig. 5.7.1 Daniel cell**

- Because of high oxidation potential zinc acts as anode and copper acts as cathode. The e.m.f. developed is due to the reactions occurring at cathode and anode.
- Anodic oxidation :  $Zn \rightarrow Zn^{2+} + 2e^{-}$   
Cathodic reduction:  $Cu^{2+} + 2e^{-} \rightarrow Cu$   
A copper ion in the copper sulphate solution accepts the liberated electrons, undergoes reduction and gets deposited on cathode.
- Thus surface atoms of the zinc rod pass into the solution and undergo corrosion.
- The e.m.f. of the cell is 1.1 volts.

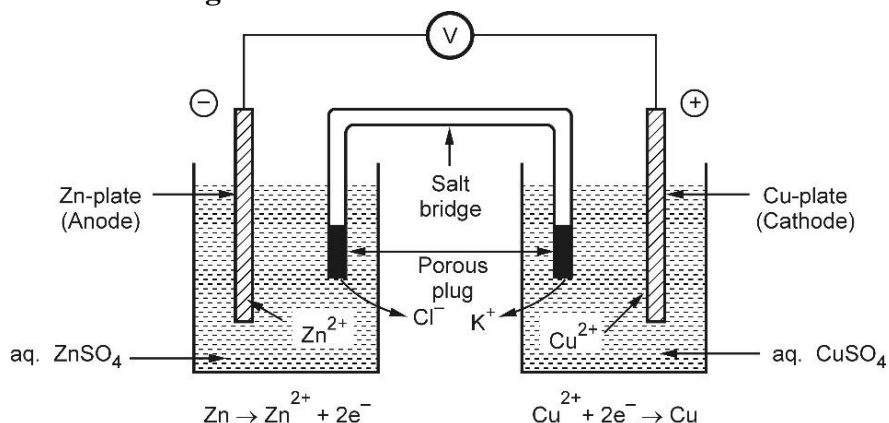

**(b) Daniel cell with salt bridge:****Fig. 5.7.2**

The cell consists of two half-cells. The zinc plate is dipped in  $\text{ZnSO}_4$  solution while the copper plate is dipped in  $\text{CuSO}_4$  solution. These plates are known as electrodes. The solutions in the two half-cells are connected by an inverted U-tube called a salt bridge. A salt bridge connects the solutions in the two half-cells and completes the cell circuit. A salt bridge keeps the solutions in the two half-cells electrically neutral.

In the oxidation half-cell, Zn atoms lose electrons and form  $\text{Zn}^{+2}$  ions. Similarly, in the reduction half-cell,  $\text{Cu}^{+2}$  ions accept electrons and get reduced to Cu. The accumulation of  $\text{Zn}^{+2}$  ions around the anode prevents the flow of electrons from the Zn rod. Similarly, the accumulation of  $\text{Cu}^{+2}$  ions around the copper plate prevents the flow of electrons to the copper ions and the cell will stop working. The accumulation of charges in the two half-cells is prevented by using a salt bridge. The sufficient number of  $\text{Cl}^{-}$  ions migrate from the salt bridge to one half-cell and  $\text{K}^{+}$  ions migrate to the other half-cell to maintain electrical neutrality.

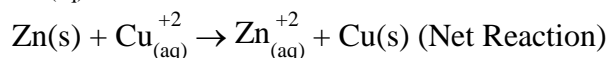
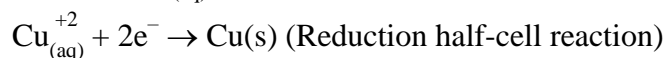
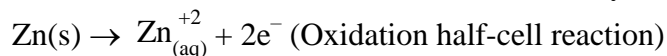
**5.8 Faraday's First and Second Law****I) Faraday's First Law**

**Statement:** "The weight of the substance deposited or liberated at respective electrode during electrolysis is directly proportional to the quantity of electricity passed through an electrolyte".

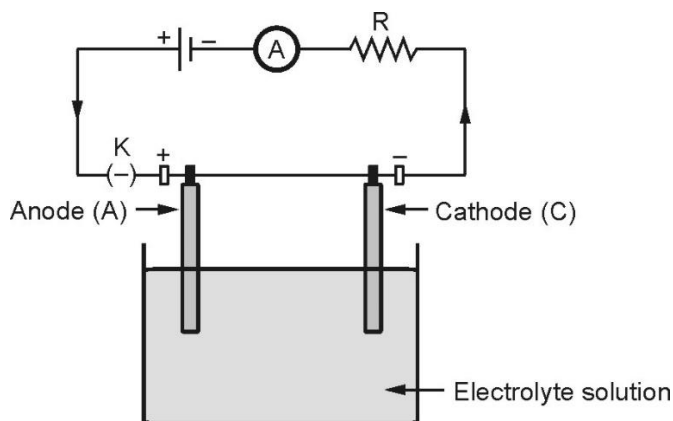

**Fig. 5.8.1**

∴ If ‘W’ is the weight of the substance liberated or deposited at an electrode and ‘Q’ is the quantity of electricity passed through an electrolyte, then

$$W \propto Q \quad \dots(5.8.1)$$

But  $Q = C \cdot t$

Where C = Current in amperes, t = Time in seconds

Substituting the value in equation (2.8.1)

$$W = Z \cdot C \cdot t \quad \dots (5.8.2)$$

Where ‘Z’ is constant. It is called as electrochemical equivalent (E.C.E.) of a substance.

In equation (5.8.2) if C = 1 amp and t = 1 sec.

Then,  $W = Z \times 1 \times 1$

∴  $W = Z$

- The electrochemical equivalent (Z) is defined as “The weight of a substance liberated or deposited when a current of one ampere is passed for one second through an electrolyte”.

## II) Faraday’s Second Law

**Statement:** “When the same quantity of electricity is passed through different electrolytes arranged in series, then the amount of substance liberated or deposited at the respective electrode is directly proportional to its chemical equivalent”.

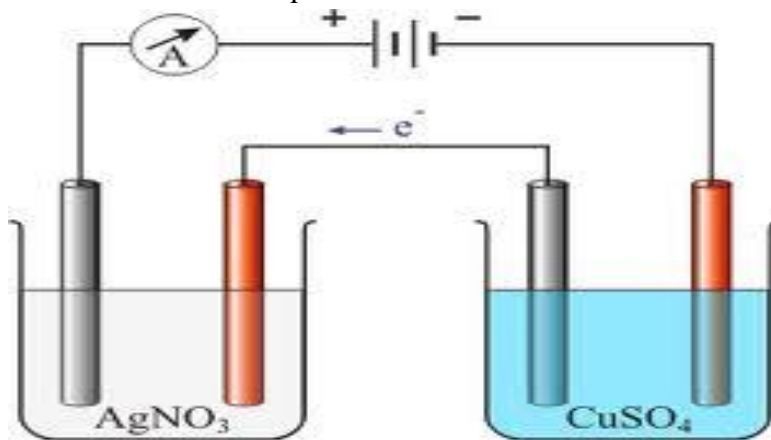

**Fig. 5.8.2**

If the same quantity of current is passed through two electrolytes  $\text{CuSO}_4$  and  $\text{AgNO}_3$  arranged in series, then ( $W_1$ ) weight of the (Cu) copper and ( $W_2$ ) weight of the silver (Ag) deposited, will be equal to their chemical equivalents of Cu and Ag respectively.

$$\therefore \frac{\text{Weight of copper deposited}}{\text{Weight of silver deposited}} = \frac{\text{C.E. of copper}}{\text{C.E. of silver}}$$

[C.E. - Chemical Equivalent (Equivalent weight)]

$$\therefore \frac{W_{\text{Cu}}}{W_{\text{Ag}}} = \frac{E_{\text{Cu}}}{E_{\text{Ag}}}$$

In general, 
$$\boxed{\frac{W_1}{W_2} = \frac{E_1}{E_2}}$$

### Relation between C.E. and E.C.E.

- **Faraday:** “One Faraday is the quantity of electricity required to liberate or deposit one gram equivalent weight of the substance”.

$$1 \text{ Faraday} = 96,500 \text{ Coulombs}$$

- **Coulomb:** “The quantity of electricity that passes through a circuit when a current of one ampere strength is passed through the circuit for one second”, is called as Coulomb.

Therefore, equivalent weight of the substance is 96,500 times the electrochemical equivalent.

$$\therefore \text{C.E. (equivalent weight)} = 96,500 \times \text{E.C.E.}$$

(Electrochemical equivalent)

### Important Formulae

$$1) \quad W = Z \cdot C \cdot t \quad \text{or} \quad W = ZQ$$

$$2) \quad CE = 96500 \times ECE (Z)$$

$$3) \quad \text{Equivalent weight} = \frac{\text{Atomic weight}}{\text{Valency}}$$

$$4) \quad \frac{W_A}{W_B} = \frac{E_A}{E_B}$$

$$5) \text{Equivalent weight of base} = \frac{\text{Molecular weight of base}}{\text{Acidity of base}}$$

$$6) \text{Equivalent weight of acid} = \frac{\text{Molecular weight of acid}}{\text{Basicity of acid}}$$

### Problems:

**Example 2.8.1 :** A current of 3 amperes passing through silver nitrate solution for 20 min. deposit 4.09 gms of silver, what is the ECE and CE of silver ?

**Solution:** By Faraday’s first law

$$W = Z \cdot C \cdot t$$

**Given:** Current (C) = 3 amp.

$$t = 20 \text{ min.} = 20 \times 60 = 1200 \text{ sec.}$$

$$W = 4.09 \text{ gms.}$$

$$\text{ECE} = ?$$

$$\text{CE} = ?$$

$$W = Z \cdot C \cdot t$$

$$4.09 = Z \times 3 \times 20 \times 60$$

$$\therefore Z = \frac{4.09}{3 \times 20 \times 60} = \mathbf{0.001136 \text{ gm/Coulombs}}$$

$$\begin{aligned} \text{CE} &= 96500 \times \text{ECE} = 96500 \times 0.001136 \\ &= \mathbf{109.21 \text{ gms.}} \end{aligned}$$

**Result:** Electrochemical equivalent (Z) = 0.001136 gm / Coulombs chemical equivalent (CE) = 109.21 gms

**Example 2.8.2:** Calculate the time in second in which 0.3 gm of Copper is liberated from copper sulphate, when a current of 0.5 ampere is passed. (Equivalent weight of Cu = 31.6 gm)

**Solution:**

**Given:** W = 0.3 gms, t = ?

C = 0.5 ampere, z = ?

CE of Cu = 31.6 gms

$$\begin{aligned} \text{ECE (Z) of copper} &= \frac{\text{Equivalent weight of copper}}{96500} \\ &= \frac{31.6}{96500} = 0.000327 \text{ gm/Coulomb} \end{aligned}$$

According to Faraday's first law

$$W = Z \cdot C \cdot t$$

$$\therefore 0.3 = 0.000327 \times 0.5 \times t$$

$$\therefore t = \frac{0.3}{0.000327 \times 0.5} = \mathbf{1834.862 \text{ sec.}}$$

**Example 2.8.3:** What current strength in amperes is required to deposit 12.7 gms of iodine from KI solution in half an hour? (Atomic weight of iodine = 127 gms)

**Solution: Given:** Weight of iodine required to deposit = 12.7 gms

$$t = 30 \text{ min.} = 30 \times 60 = 1800 \text{ secs.}$$

Atomic weight of I<sub>2</sub> = CE = 127 gms.

$$\text{CE} = 96500 \times \text{ECE}$$

$$\therefore \text{ECE} = \frac{\text{CE}}{96500} = \frac{127}{96500}$$

$$\therefore Z = 0.0013 \text{ gms/Coulomb}$$

By Faraday's first law,

$$W = Z \cdot C \cdot t$$

$$\begin{aligned} \therefore C &= \frac{W}{Z \cdot t} = \frac{12.7}{0.0013 \times 1800} \\ &= \frac{12.7}{2.34} = \mathbf{5.42 \text{ amperes}} \end{aligned}$$

**Example 2.8.4:** A given quantity of electricity is passed through two cells containing  $\text{CuSO}_4$  and  $\text{AgNO}_3$  solutions respectively. If 0.99 gram Ag and 0.29 gm of Cu are deposited, find equivalent weight of \_\_\_\_\_ of \_\_\_\_\_ Ag.

[Equivalent weight of Cu = 31.6]

**Solution: Given:**

Weight of Ag deposit = 0.99 gms

Weight of Cu deposit = 0.29 gms

Equivalent weight of Cu = 31.6 gms.

Equivalent weight of Ag = ?

Using Faraday's second law:

$$\therefore \frac{W_{\text{Ag}}}{W_{\text{Cu}}} = \frac{E_{\text{Ag}}}{E_{\text{Cu}}}$$

$$\therefore \text{Equivalent weight of Ag deposited} = \frac{0.99}{0.29} \times 31.6 = \mathbf{107.87 \text{ gms.}}$$

**Equivalent wt of Ag is 107.87 gms.**

**...Ans.**

**Example 2.8.5 :** When the same amount of current is passed through the solutions of  $\text{CuSO}_4$  and  $\text{ZnSO}_4$  then 0.7 and 0.716 gms of Cu and Zn get deposited on respective electrodes. Calculate equivalent weight of zinc. (Atomic weight of copper = 63.5 gms)

**Solution: Given:**

Weight of Cu deposited = 0.7 gms

Weight of Zn deposited = 0.716 gms

$$\begin{aligned} \text{Equivalent weight of Cu} &= \frac{\text{Atomic weight}}{\text{Valency}} \\ &= \frac{63.5}{2} = 31.75 \text{ gms} \end{aligned}$$

$$E_{\text{Zn}} = ?$$

Using Faraday's second law

$$\begin{aligned} \therefore \quad \frac{W_{\text{Cu}}}{W_{\text{Zn}}} &= \frac{E_{\text{Cu}}}{E_{\text{Zn}}} \\ \therefore \quad \frac{0.7}{0.716} &= \frac{31.75}{E_{\text{Zn}}} \\ \therefore \quad E_{\text{Zn}} &= \frac{0.716 \times 31.75}{0.7} \\ \therefore \quad \text{Equivalent weight of Zn} &= \mathbf{32.4757 \text{ gms.}} \end{aligned}$$

### Problems for Practice

**Example 2.8.6 :** A solution of metal salt was electrolysed for 10 minutes with a current of 1.5 ampere. The weight of metal deposited was 0.685 gm. What is the equivalent weight of the metal.

[ Ans. : Equivalent weight of metal = 73.44 gms. ]

**Example 2.8.7 :** A current of 5.0 ampere flowing for 0.5 hour deposits 3.0489 of a metal at cathode. Calculate the equivalent weight of the metal. [1 Faraday = 96500 Coulomb]

[ Ans. : Equivalent weight of metal = 32.81 gms. ]

**Example 2.8.8 :** A solution of a bivalent metal salt was electrolysed for 10 minutes with a current of 1.5 ampere. The weight of the metal deposited was 0.685 gm. What is the atomic weight of the metal.

[Ans. : Atomic weight of the metal is 146.89 gms.]

**Example 2.8.9 :** Same quantity of current was passed through  $\text{CuSO}_4$  and  $\text{AgNO}_3$  solutions. If 3.207 gms Cu is deposited, Calculate weight of silver deposited. Equivalent weight of copper = 31.77 gms. Equivalent weight of Ag = 108 gms.

[Ans. : Weight of silver deposited = 10.902 gms.]

**Example 2.8.10 :** What current strength in amperes will be required to liberate 12.7 gms of iodine from KI solution in 40 minutes ? (Given ECE of iodine = 0.0013)

[Ans. : Current (C) = 4.07 amperes]

**Example 2.8.11:** A solution of metal salt was electrolyzed for 10 minutes with a current of 1.5 ampere. The weight of the metal deposited is 0.685 gms. What is the equivalent weight of the metal?

[Ans.: Equivalent weight of the metal is 73.44 gms.]

## 2.9 Mechanism of Electrolysis

**Electrolysis:** “A chemical change produced by the passage of electric current resulting in chemical decomposition of the substance is known as electrolysis”.

### Electrochemical series:

Cations and anions are arranged in the order of their decreasing activity. A more active metal readily forms its ion (cation) by the loss of electron and such ion has fewer tendencies to accept electron. Such cation is difficultly discharged at the cathode.

### Electrochemical series of cations and anions:

If a solution of electrolyte contains two or more cations or anions, then according to the electrode potential of cation/anion it will undergo oxidation or reduction reaction. The position of element in electrochemical/ galvanic series plays vital role in electrochemistry.

Table 5.7

<b>The Electrochemical Series</b>	
$K^+$	$F^-$
$Na^+$	$SO_4^{2-}$
$Ca^{2+}$	$NO_3^-$
$Mg^{2+}$	$Cl^-$
$Al^{3+}$	$Br^-$
$Zn^{2+}$	$I^-$
$Fe^{2+}$	$OH^-$
$Sn^{2+}$	
$Pb^{2+}$	
$H^+$	
$Cu^{2+}$	
$Ag^+$	

  
Ease of discharge increases

### Some of the important examples of electrolysis:

**Example 1:** Electrolysis of aqueous copper sulphate solution using platinum electrode.

**Definition: Electrolysis:** A process of chemical decomposition of the substance due to the passage of electric current is known as electrolysis.

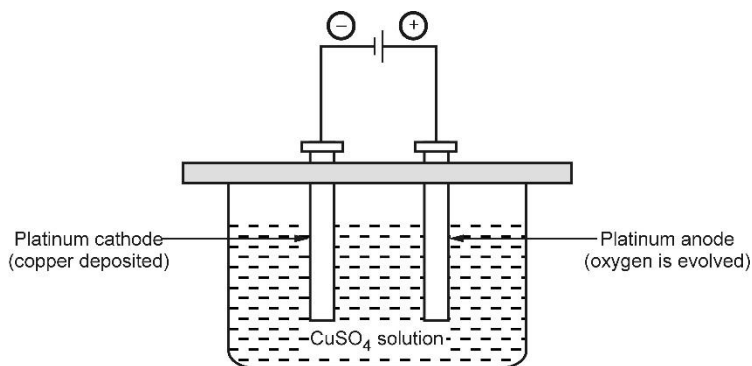
**Diagram:****Fig. 5.9.1**

**Ionization:**  $\text{CuSO}_4$  solution is ionized to  $\text{Cu}^{++} + \text{SO}_4^{--}$

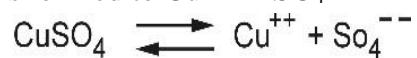

- 1)  $\text{CuSO}_4$  solution contains  $\text{Cu}^{++}$ ,  $\text{SO}_4^{--}$ ,  $\text{H}^+$ ,  $\text{OH}^-$  ions.
- 2) According to electrochemical series,  $\text{Cu}^{++}$  ions are discharged at the cathode in preference to  $\text{H}^+$  ions & copper is deposited on cathode.
- 3) According to electrochemical series,  $\text{OH}^-$  ions are discharged at anode in preference to  $\text{SO}_4^{--}$  ions & oxygen gas is liberated at anode.

**Reaction at Cathode: (Reduction Reaction)**

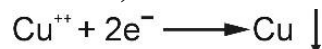

**Reaction at Anode: (Oxidation Reaction)**

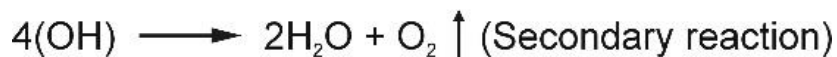
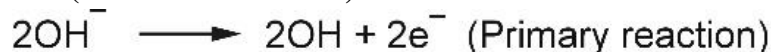

**Net Result:**

- 3) At cathode, Cu metal is deposited
  - ii) At anode,  $\text{O}_2$  gas is evolved
  - 4) In electrolytic cell, colourless Sulphuric acid is formed.
- $$(2\text{H}^+ + \text{SO}_4^{--} \longrightarrow \text{H}_2\text{SO}_4)$$

Therefore, blue colour of  $\text{CuSO}_4$  becomes faint and finally turns to colourless after electrolysis.

**Example 2:** Electrolysis of fused (molten) NaCl using carbon (graphite) electrodes.



**Diagram:**

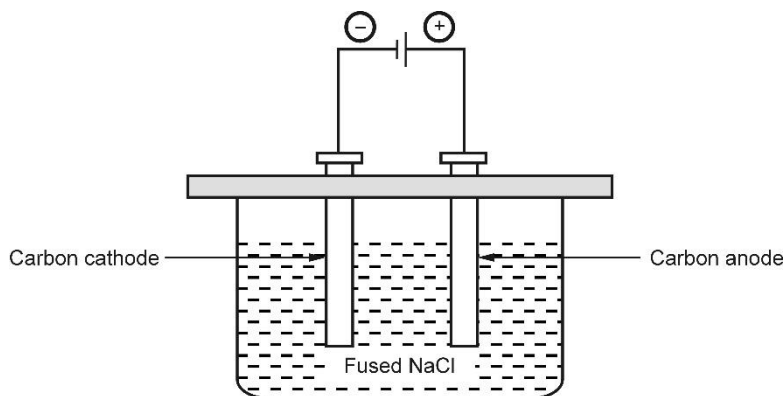

**Fig. 5.9.2**

1. Fused NaCl contains  $\text{Na}^+$ ,  $\text{Cl}^-$  ions.
2. At cathode,  $\text{Na}^+$  ions are discharged and sodium is deposited.
3. At anode,  $\text{Cl}^-$  ions are discharged and chlorine gas is liberated.

**Ionisation :** NaCl is ionized to  $\text{Na}^+ + \text{Cl}^-$



**Reaction at Cathode:**

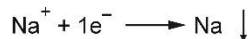

**Reaction at anode**



**Net Result:**

- i) At cathode, sodium is deposited.
- ii) At anode, chlorine gas is liberated.

**Example 3:** Electrolysis of aqueous NaCl using carbon electrodes.

**Diagram:**

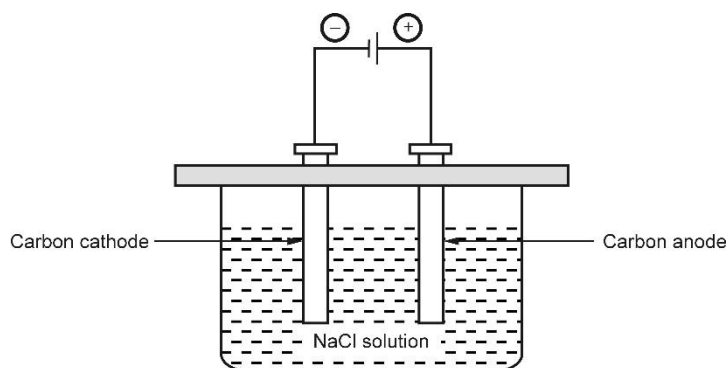

**Fig. 5.9.3**

1. NaCl solution contains  $\text{Na}^+$ ,  $\text{Cl}^-$ ,  $\text{H}^+$ ,  $\text{OH}^-$  ions
2. According to electrochemical series,  $\text{H}^+$  ions are discharged at the cathode in preference to  $\text{Na}^+$  ions & hydrogen gas is liberated at cathode.

3. According to electrochemical series,  $\text{Cl}^-$  ions are discharged at anode in preference to  $\text{OH}^-$  ions and chlorine gas is liberated at anode.

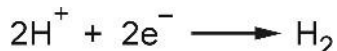
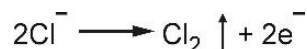
**Ionization:****Reaction at Cathode:****Reaction at anode:****Net Result:**

- 5) At cathode, hydrogen gas is liberated.  
 ii) At anode, chlorine gas is liberated.  
 6) In electrolytic cell, the concentration of  $\text{Na}^+$  and  $\text{OH}^-$  ions increases and Sodium hydroxide is formed.

**Example 4:** Electrolysis of copper sulphate using copper electrodes.

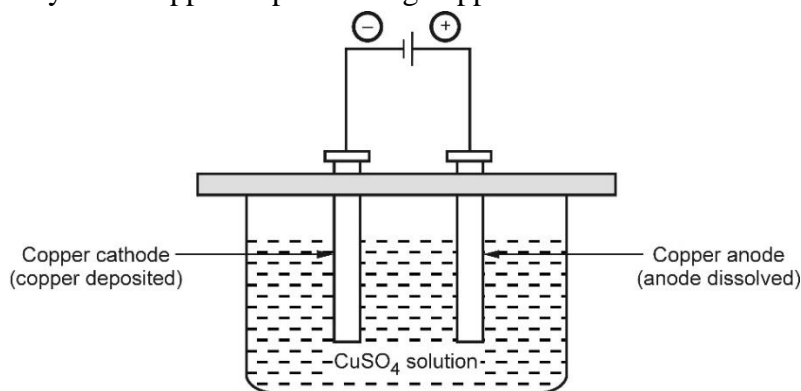

**Fig. 5.9.4 Mechanism of electrolysis**

**Process:**

- 7) Two copper electrodes are immersed in  $\text{CuSO}_4$  solution.  
 ii) One copper electrode is connected to positive terminal of the battery which acts as a anode. The other copper electrode is connected to the negative terminal of the battery and acts as a cathode.  
 iii) Aqueous solution of copper sulphate acts as an electrolyte. It undergoes dissociation.

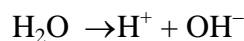
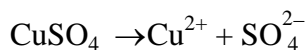

The solution contains  $\text{Cu}^{2+}$ ,  $\text{SO}_4^{2-}$ ,  $\text{H}^+$  and  $\text{OH}^-$  ions.

- 8) After passage of electric current,  $\text{Cu}^{2+}$  ions get discharged at the cathode in preference to  $\text{H}^+$  ions and undergo reduction.



- 9) At anode surface metal atoms undergo oxidation with liberation of electrons.



**Net result:**

- 1) Copper metal is deposited at cathode and size of cathode increases.
- 2) Size of anode decreases.

**a) Electroplating**

**Electroplating:** "Coating of superior metal on inferior metal by means of electric current is called as electroplating".

For example: Silver plating

**Process:**

- 1) Article to be electroplated is cleaned by using alkali, acid and finally with water to remove impurities present on the surface of article.
- 2) Cleaned article or spoon is connected to negative terminal of the battery (cathode). Pure silver rod is connected to the positive terminal of the battery (anode).
- 3) Both cathode and anode are immersed in potassium argentocyanide solution which acts as an electrolyte.
- 4) Dissociation reaction of  $\text{K} [\text{Ag} (\text{CN})_2]$  is as follows:

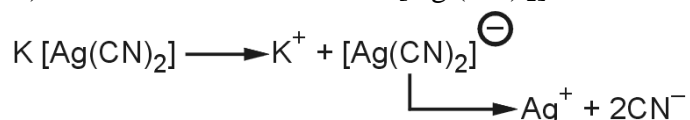

After passage of electric current,  $\text{Ag}^{+}$  ions from electrolyte gets deposit on iron spoon and undergo reduction.

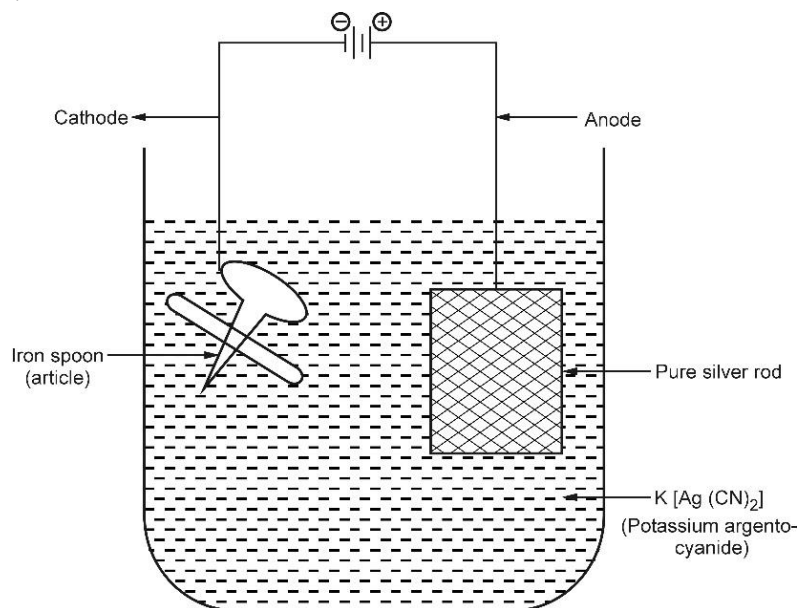

**Fig. 5.9.5 : Process of eletroplating**

Cathodic reduction:  $\text{Ag}^{+} + \text{e}^{-} \rightarrow \text{Ag}$

At the same time surface silver atoms at anode undergo oxidation and pass into the solution.

Anodic oxidation:  $\text{Ag} \rightarrow \text{Ag}^{+} + \text{e}^{-}$

Uniform coating of silver metal is obtained on iron spoon, while more active  $K^+$  and  $H^+$  ions remain in the solution as they require very high voltage for their discharge.

### Purposes of electroplating

- 1) Protection of base metal from corrosion.
- 2) A coating of superior metal on inferior metal is done to make it attractive.
- 3) The broken machine parts can be repaired by electroplating.

#### ➤ Materials suitable for electroplating

The materials used in the plating (coating) process depend on the composition of the plating bath and the deposition conditions. Here are the most commonly used materials:

**Table 5.8**

Black nickel/chromium	Copper
Chromium	Tin
Palladium or Palladium Nickel Alloy	Nickel
Gold	Silver
Platinum	Ruthenium
Cadmium	Zinc

#### ➤ Common Electroplating Processes with applications

**Table 5.9**

Metal	Anode	Electrolyte	Application
Cu	Cu	20% $CuSO_4$ , 3% $H_2SO_4$	electrotype
Ag	Ag	4% $AgCN$ , 4% $KCN$ , 4% $K_2CO_3$	jewellery, tableware
Au	Au, C, Ni-Cr	3% $AuCN$ , 19% $KCN$ , 4% $Na_3PO_4$ buffer	jewellery
Cr	Pb	25% $CrO_3$ , 0.25% $H_2SO_4$	automobile parts
Ni	Ni	30% $NiSO_4$ , 2% $NiCl_2$ , 1% $H_3BO_3$	Cr base plate

Zn	Zn	6% Zn(CN) <sub>2</sub> , 5% NaCN, 4% NaOH, 1% Na <sub>2</sub> CO <sub>3</sub> , 0.5% Al <sub>2</sub> (SO <sub>4</sub> ) <sub>3</sub>	galvanized steel
Sn	Sn	8% H <sub>2</sub> SO <sub>4</sub> , 3% Sn, 10% cresol-sulfuric acid	tin-plated cans

### b) Electro refining of Copper

**Electro refining:** “It is the process of obtaining extra pure metal from impure metal by using electric current”.

For example: Electro-refining of blister copper.

Blister copper contain 3-5 % impurities of active metals like zinc, iron, nickel and passive metals like platinum, gold, antimony, silver.

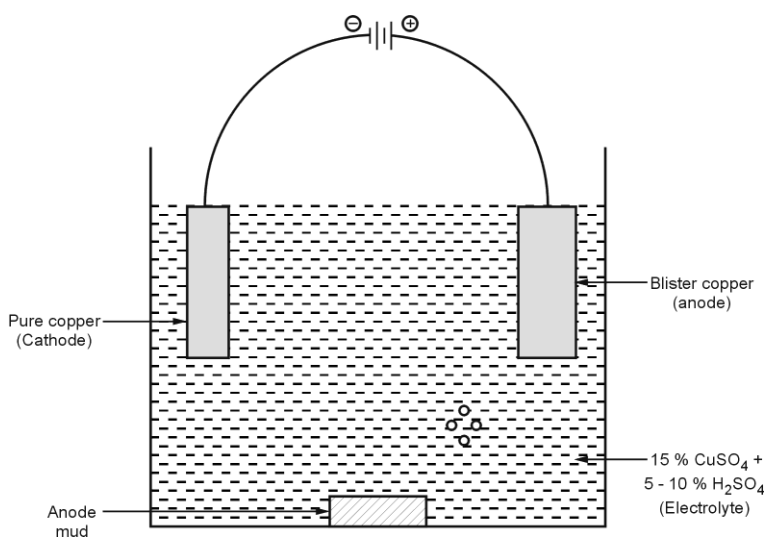

**Fig. 5.9.6 Process of electro-refining**

#### Process:

- 1) The process is carried out in large tank. The thick block of blister copper is connected to anode and thin wire of pure copper is connected to the cathode. Mixture of 15 % CuSO<sub>4</sub> and 5-10 % H<sub>2</sub>SO<sub>4</sub> is used as an electrolyte.
- 2) A direct current of low voltage is passed through an electrolyte, at this voltage, impurities of more active metals like Zn, Ni, Fe pass into the solution in the form of ions. The less active metals like Ag, Au, Pt gets settle down at the bottom forming ‘anode mud’ from which they are extracted.
- 3) At proper voltage only Cu<sup>2+</sup> ions are discharged at the cathode, undergo reduction and gets deposit on cathode.



99.99 % pure copper is obtained by this process.



2. Engineering Chemistry By Jain and Jain ISBN: 9352160002; 2015.
3. Fundamental of electrochemistry By Bagotsky, V.S. ISBN: 9780471700586; 2005.
4. Textbook of Basic chemistry, Technical Publication By Dr. Kashmiri A. Khamkar, V.M.Gokhale, C.S.Raut. ISBN: 9789333214810.

**MOOCs:**

1. <https://www.youtube.com/watch?v=0WKyy9QEyH4>
2. <https://www.youtube.com/watch?v=-K8Xb2tUWbY>
3. <https://www.youtube.com/watch?v=7Gb3sidzF0g>
4. <https://www.youtube.com/watch?v=kBgHPfkGbmK>
5. <https://www.youtube.com/watch?v=SgcYo9W0qfM>

## Unit 6

### Paint, Varnishes, Insulators, Polymer, Adhesives and Lubricants

**Course Outcome :** Use relevant engineering materials in industry.

**Unit Outcomes :**

- 6a. Identify the ingredients of the given paints.
- 6b. Differentiate salient properties of the given paint and varnish.
- 6c. Describe the properties of insulating materials for the given applications.
- 6d. Differentiate the given types of structural polymers.
- 6e. Describe the polymerization process of the given polymer.
- 6f. Explain the properties and uses of the given polymer elastomer and adhesives.
- 6g. Describe the application of relevant adhesives required for the given material.
- 6h. Explain the properties of given type of lubricants.

**Rationale:** Polymer, Plastic, Resins are materials which have changed a world in 19 th century. Polymers are widely used in electronic, automobile sector, chemical industries, domestic applications.

Paint and Varnish protect the substrates like metaks, woods, plastic, ceramic ware, wall from environmental attack. They also provide asthetic and pleasent look.

Lubricant is a substance which reduces friction, heat and wear and tear when introduced between two moving surfaces. Using the correct lubricant helps to maximize the life of machinery there by saving money, time and manpower. Thus making operations more efficient and more reliable.

The knowledge of insulator is essential to keep us safe from the attack of heat, electricity and large sound. The insulators are the substances which prevent the transfer of heat, sound and electricity.

#### 6.1. Paints

**Significance:** Paints and varnishes are widely used as materials for covering surfaces for decorative and protective purposes. The knowledge of paint and varnish helps the technologist to select proper painting material for the engineering applications. Increasing urbanisation in the developing as well as developed economics is positively affecting the paint and varnish market.

Paint is a mechanical dispersion mixture of one or more pigments in a vehicle.

A pigment is solid colouring material suspended in a liquid medium (vehicles, thinner) that on drying forms protective or decorative film on various surfaces. Paint dries up by oxidation, polymerization or evaporation of its components and gives a thin film which has considerable hiding power. Paint is used as a final finishing to any surface and also as a coating to protect and decorate the surfaces. Paint film is opaque so it is very useful to completely cover and hide the surface. Paint is available in different forms: oil based, cement based and water based.



### 6.1.1 Purposes of Applying Paint:

Paints are generally used for covering the metallic and non-metallic surfaces and also for the construction work. The main purposes of applying paint are as follows:

- 1) Paint protects the iron from corrosion and rusting.
- 2) Paint protects the iron from wear and tear.
- 3) Paint protects the wooden surfaces from insects and fungi.
- 4) Paint protects the wooden surfaces from moisture.
- 5) Paint reflects the heat and light.
- 6) Paint provides beautiful appearance to the surface on which it is applied.
- 7) Paint provides smoothness to the surfaces.
- 8) To give aesthetic look.

### 6.1.2 Characteristics of Good Paint

The characteristics of good paint are as following:

- 1) It should be easily applicable on the surface with a brush, roller or spraying devices.
- 2) It should possess a high spreading or covering power.
- 3) It should cover the body uniformly and homogeneously on which it is applied.
- 4) It should be resistant to wear and tear of the atmosphere.
- 5) It should maintain its colour, smoothness and finish for a long time.
- 6) The film produced should be washable.
- 7) The film should be glossy and attractive.
- 8) It should protect the surface against chemical and environmental effect for a long time.
- 9) It should be elastic.
- 10) It should possess good adhesion capacity on the surface.
- 11) It should be cheap and ready to use.
- 12) The film should not crack or shrink on drying.
- 13) When paint is applied on a metal, it should resist corrosion.

### 6.1.3 Ingredients of Paint / Constituents of Paint

- |                                 |                                      |
|---------------------------------|--------------------------------------|
| 1) Pigment                      | 2) Vehicle or film forming materials |
| 3) Thinners                     | 4) Driers                            |
| 5) Pigment extenders or fillers |                                      |
| 6) Plasticizers                 | 7) Ant skinning agents               |

#### 1) Pigment:

It is an essential constituent of paint. Pigment is a solid substance added during manufacturing of paint, which gives color and opacity to the paint.

#### Examples:

White - White lead, Zinc oxide, Titanium oxide

Coloured pigments:

Red – Red lead, Ferric oxide, Chrome red, Venetian red

Green – Chromium oxide

Blue – Prussian blue

Black – Carbon black

Brown – Umber brown

**Functions of pigment:**

- 1) Pigment provides opacity to the paint film.
- 2) It provide desired colour to the paint.
- 3) It gives protection to the paint film by reflecting harmful ultraviolet radiations.
- 4) It provides durability and strength to the paint film.
- 5) It improves impermeability of the film to the moisture.
- 6) Pigment imparts aesthetic appeal to the film.

**2) Vehicle or film forming materials:**

It is a film forming constituent of paint. Vehicles are a carrier for non-volatile components of paint.

**Examples:**

The commonly used vehicles for oil paints are - linseed oil, soyabean oil, dehydrated castor oil, fish oil etc. Water is the main vehicle for water based paint.

**Functions of vehicle:**

- 1) It provides toughness and durability to the paint film.
- 2) It provides good adhesion to the film.
- 3) It provides water proofness to the film.
- 4) It helps to form the film by evaporation or by oxidation and polymerization of the unsaturated constituents of the drying oil.

**3) Thinner**

Thinner is a colorless solvent that are added in the paint. A thinner is used to thin oil based paints so that the paint is easy to apply on the surface. The thinner evaporates while drying the paint and get dry pigmented film.

**Examples:**

Turpentine, mineral spirit, benzene, dipentene, naptha, toluene, xylol, kerosene, methylated naphthalene etc.

**Functions of Thinner:**

- 1) It reduces the fluidity of paint.
- 2) It makes the paint smoother.
- 3) It helps to penetrate the paint into porous structures.
- 4) It helps to dry the paint film by evaporation.
- 5) It suspends the pigment.

**4) Driers**

Driers are oxygen carrier catalyst.

**Examples :**

Resinates, linoleates, tungstates and naphthnates of Co, Mn, Pb and Zn.

**Functions of Driers:**

- 1) It increases the rate of drying of paint film by oxidation, polymerization and condensation.
- 2) It improves the drying quality of the oil film.

**5) Pigment extenders or fillers:**

Fillers are the inert solid material added to the paint. They do not effect on the colour of the paint but they do alter some properties.

**Examples:**

Quartz, Sand ( $\text{SiO}_2$ ), Talc, Baryte ( $\text{BaSO}_4$ ), Kaoline, clay, Limestone ( $\text{CaCO}_3$ ) etc.

**Function of fillers or extenders:**

- 1) It increases the durability of the paint.
- 2) It reduces the cracking of paint film after drying.
- 3) They increase the random arrangement of pigment particles.
- 4) They act as a carrier substance for pigments.
- 5) They are used to fill the voids or pores in the paint.
- 6) It reduces the cost of paint.
- 7) It gives good adhesion, hardness and toughness to the paint film.
- 8) It provides a water resistance to the paint.

**6) Plasticizers:**

Plasticizers are the substance which imparts elasticity to the paint film after addition and prevents the cracking of film after drying.

**Examples :**

Tricresyl phosphate, triphenyl phosphate, tributyl phosphate, diamyl phthalate, dibutyl tartarate.

**7) Antiskinning agent**

The antiskinning agent like polyhydroxy phenols sometimes added to the paint. Their function is to prevent gelling and skinning of the paint film.

**Table 6.1**

Constituent of Paint	Function
1. Pigment	1. Impart Color, opacity, aesthetic look 2. Protect paint film by reflecting ultra violet light.
2. Drying oil or medium	1. Film forming constituent. 2. Impart water proofness and durability.

3. Thinner	1. Reduce the viscosity of the paint. 2. Dissolve film forming constituent and suspend the pigment.
4. Driers	1. Acts as the oxygen carrier catalyst and 2. Improve the drying quality of the paint.
5. Extenders	1. Increases the durability of the paint 2. Acts as a pigment carrier.
6. Plasticizers.	1. Prevent cracking. 2. Impart elasticity.
7. Antiskinning agent	1. prevent gelling and skinning of the paint film

## 6.2 Varnish

### Introduction

Varnish is a solution of a natural or synthetic resins in drying oil or in volatile solvent or in drying oil and volatile solvent (thinner) both. When it is applied on a surface, it gives a transparent, hard, protective film. The film dries up by evaporation, oxidation and polymerization of its constituents leaving behind glossy, lustrous and durable film.

### 6.2 Types of Varnish

There are two main types of varnishes

#### 1) Oil varnish or oleoresinous varnish

It is a mixture of natural or synthetic resin and thinner (volatile solvent). Oil varnish dries up by evaporation of volatile solvent followed by oxidation and polymerization of the drying oil.

The presence of oil reduces the brittleness of the film.

For example: **Copal varnish**

Copal varnish is prepared by mixing copal in linseed oil (drying oil) and turpentine (thinner)

#### 2) Spirit varnish

It is a mixture of resin in a volatile solvent (thinner). Spirit varnish dries up by evaporation of the volatile solvent and the film produced is brittle and has a tendency to crack and peel off. To avoid the brittleness of film small amount of plasticizer is added in a spirit varnish. Such a varnishes are usually used for polishing wooden surfaces.

For example: A solution of resin shellac in alcohol.

### 6.2.1 Difference between Paints and Varnishes

Table 6.2

Sr. No.	Paints	Varnishes
1)	Paint is a mixture of pigment in vehicle.	Varnish is a mixture of resin in drying oil or thinner or in both.

2)	Paint contains pigments.	Varnish do not contains pigment.
3)	Paint produces opaque film.	Varnish produces transparent film.
4)	Painted surface reflects heat and light.	Varnished surface do not reflects heat and light.
5)	Paint has different colours.	Varnish has little or no colour.

### 6.3 Thermal Insulator

#### Significance:

Insulators play a vital role in the three phases of power sector of generation, transmission and distribution. Insulators used for high-voltage power transmission lines are made from glass, porcelain or composite polymer materials. Industrial insulators are used to create air gape for ensuring as effective insulation between two or more conductors. Insulators form an integral part of transmission and distribution and helping resisting stresses as well such against heat, cold and contamination.

**Insulator:** Thermal insulators are defined as “The material or combination of materials that retard the transfer of heat”. Heat may be transmitted between materials by the process of convection, conduction or radiation. Heat always flows from warmer to cooler surfaces until temperature of both surfaces becomes equal. Thermal insulators retard this flow of heat.

#### 6.3 Characteristics of Thermal Insulators:

An ideal insulating material should have following characteristics.

- 1) It should have extremely low thermal conductivity.
- 2) It should be chemically inert.
- 3) It should be able to withstand vibrations, abrasion and bending.
- 4) It should be stable at different working temperatures.
- 5) It should be fire-proof.
- 6) It should be capable to withstand the loads.
- 7) It should be odourless.
- 8) It should have low density.
- 9) It should be water-proof.

#### 6.3.1 Classification of Thermal Insulators:

Thermal insulators are classified into two types.

##### 1) Organic thermal insulators

These are based on hydrocarbon polymers, which can be expanded to obtain high void structure. These are suitable up to 150 °C temperature.

For example: Thermocole (Expanded polystyrene) Polyurethane Foam (PUF), wool, cotton, paper, charcoal powder, saw dust, coke powder, rubber.

##### 2) Inorganic thermal insulators

These are based on Siliceous / Aluminous / Calcium materials in fibrous, granular or powder form. These are suitable above 150 °C.

For example: Mineral wool, calcium silicate, glass wool, porous silica, refractory insulating bricks, asbestos paper, asbestos fibre etc.

### **6.3.2 Glass wool:**

Glass wool is an insulating material prepared from the fibers of glass. The glass fibers are prepared from the molten glass, flows into a cylindrical container having small holes. The container rotates rapidly and the horizontal stream of glass flows out the holes. The molten glass streams are converted into fibers by a downward blast of air. The fibers fall onto a conveyor belt and are arranged using a binder into a texture similar to wool.

Glass wool is produced in rolls or in slabs with different thermal and mechanical properties.

#### **Properties of glass wool:**

- 1) It has extremely low thermal conductivity.
- 2) It is chemically inert.
- 3) It is non-corrosive.
- 4) It is highly resistance to moisture.
- 5) It has good tensile strength.
- 6) It is fire-proof.
- 7) It has low density.

#### **Applications of glass wool:**

- 1) It is used in ovens, refrigerators.
- 2) It is used to insulate the flat surfaces such as cavity wall insulation, ceiling tiles, curtain walls, as well as ducting.
- 3) It is used to insulate piping and for sound proofing.
- 4) It is used for electrical insulation.
- 5) It is used in air filters as a dust filtering material.

### **6.3.3 Thermocole:**

Thermocole is made by blowing gas into polystyrene, due to which it expands into a solid foam like material called Thermocole or EPS (Expandable Polystyrene). It is spongy, porous foam like structure contains 3-6 million discreet cells per liter giving it excellent insulating property.

#### **Properties of Thermocole**

- 1) It has extremely low thermal conductivity.
- 2) It is light in weight.
- 3) It is shock proof.
- 4) It is chemically inert.
- 5) It has low electrical conductivity.
- 6) Its density is low (15-30 kg/m).
- 7) It is quite strong and tough.
- 8) It has spongy porous and foam like structure.
- 9) It can be cut easily with simple tools like knife or a saw.

- 10) It is highly resistance to moisture.
- 11) It has good tensile strength (3-6 kg/cm)

#### **Applications of Thermocole:**

- 1) It is used in industrial refrigeration, cold storage, cooled rooms, domestic refrigerator and air conditioning.
- 2) It is used in building ceilings, false ceilings roofs, walls, floors, door, partitions and cemented water tanks.
- 3) It is used in cinema halls, factories, offices.
- 4) It is used for packing delicate equipment like electronic goods, glassware etc.
- 5) It is used for decorations.
- 6) It is used for sound proofing.

## **6.4 Polymers**

**Significance:** Polymers are the materials of very high molecular weight that have many applications in our modern society. Polymers make up many of the materials in living organisms, including proteins, cellulose. They constitute the basis of minerals like diamond, quartz, feldspar and such man-made materials as concrete, glass, paper, plastics and rubber. According to specific requirements, polymers have been used in devices for replacing deficient parts or assisting different functions of the body because of their special physical and mechanical properties. With the development of Nano biotechnology, more sophisticated polymers have been developed.

**Polymers:** In Greek, poly = many, mers = parts or segments.

“Polymers are very large molecule that are made up of thousands even millions of atoms that are bonded together in a repeating pattern”. The molecular links in the polymer chain are called repeated units. “The repeating units in the polymer chain called **monomers**”. In order to form polymers, monomers should either have double or triple bond or reactive functional group.

- **Polymerization:** The process in which large number of small molecules (monomers) linking together to form a large molecule (polymer) in presence of temperature, pressure and catalyst is known as polymerisation.
- **Degree of Polymerisation:** “**The number of repeating units present in polymer is called as degree of polymerisation.**” It represents the number of repeating units in polymeric chain. For example, if polymer contains 1000 repeating units then the degree of polymerisation is 1000.

### **6.4 Classification of Polymers or Plastics:**

#### **6.4.1 Classification on the basis of monomers:**

- i) Homopolymer
- ii) Copolymer

#### **i) Homopolymer**

The polymers formed from the same type of monomers are called homopolymers.



For example: Polyethylene, PVC, polystyrene etc.

### ii) Copolymer

The polymers formed from the two or more different repeating monomers are called copolymers.

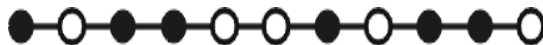

Example: Styrene acrylonitrile, styrene butadiene, acrylonitrile butadiene styrene, bakelite, Nylon 66 etc.

### Difference between homopolymers and Copolymers:

**Table 6.3**

Sr.No.	Homopolymers	Copolymers
1)	These are formed by addition polymerization.	These are formed by condensation polymerization
2)	These are formed by same type of monomers.	These are formed by different repeating monomers.
3)	They have simple structure.	They have complex structure.
4)	For example: PVC, Polyethylene, Polystyrene, etc.	For example: Polyvinyl acetate, Styrene butadiene etc.

### 6.4.2 Classification on the basis of thermal behavior:

- i) Thermoplastics ii) Thermosetting

#### i) Thermoplastics

These are formed by addition polymerization. Thermoplastic resin becomes soften on heating and harden on cooling without appreciable changed of properties.

For example:: Polyethylene, polystyrene, PVC, cellulose nitrate, cellulose acetate etc.

#### ii) Thermosetting

Thermosetting plastics are formed by condensation polymerization and these plastics having the property of becoming permanently hard and rigid. When heated they does not become soft again.

For example: Bakelite, Nylon 66, Urea-formaldehyde etc.

### • Difference Between Thermoplastics and Thermosetting Plastics:

**Table 6.4**

Sr. No.	Thermoplastic	Thermosetting Plastic
1)	These are formed by addition polymerization.	These are formed by condensation polymerization.
2)	They exhibit linear structure.	They exhibit cross-linked structure.
3)	They have low molecular weight.	They have high molecular weight.
4)	They are soft, weak, less brittle.	They are hard, strong, more brittle.
5)	Their intermolecular bonds are	Their intermolecular bonds are strong



	weaker.	covalent bonds.
6)	They are soluble in organic solvents.	They are soluble in inorganic solvents.
7)	They become soften on heating, hence can be reshaped and reused.	They do not become soften on heating, hence cannot be reshaped and reused.
8)	Ex: PVC, Polyethylene etc.	Ex: Bakelite, Nylon 66

### 6.4.3 Classification on the basis of monomer structure:

- i) Linear polymers and ii) Cross-linked polymers

#### i) Linear polymers

In this type of polymers monomers are joined with each other and formed long and straight chain.



For example: Polythene, PVC, polystyrene, Teflon etc.

#### ii) Cross linked polymers

In this type of polymers, monomers are joined with each other and formed a network or cross-linked structure.

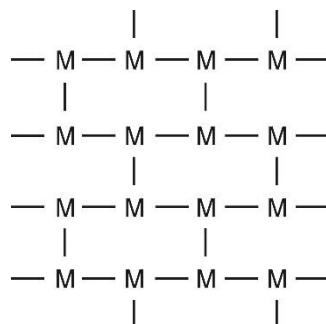

For example: Bakelite, Nylon-66 etc.

- Difference Between Linear and Cross-linked/Branched Polymers

**Table 6.5**

Sr.No.	Linear Polymer	Cross-linked or Branched Polymer
1)	The monomers are joined with each other and formed linear structure.	The monomers are joined with each other and formed cross-linked structure.
2)	These are formed by same type of monomers.	These are formed by different types of monomers.
3)	Ex: PVC, Polyethylene, Polystyrene, etc.	Ex: Bakelite, nylon 66 etc.

## 6.5 Types of Polymerization Reactions:

### a) Addition polymerization

### b) Condensation polymerization

#### a) Addition polymerization:

The polymers formed by repeated addition of same type monomers without elimination of by products like water, ammonia, methanol are called addition polymerization.

For example: Polyethylene, polystyrene, PVC, Teflon etc.

#### b) Condensation polymerization

The polymers formed by condensation of different types of monomers with elimination of small molecules like water, ammonia, methanol are called condensation polymerization.

For example: Phenol-formaldehyde resin (Bakelite), polyester, epoxy resin, nylon 66.

### 6.5.1 Synthesis of Polymers:

#### a) Synthesis of Polyethylene

The monomer used in this formation is ethylene. One of the double bond between carbon atoms is open up leaving one electron to each carbon atom and forming unstable molecule. The unstable molecules joined with similar molecule to form polymer.

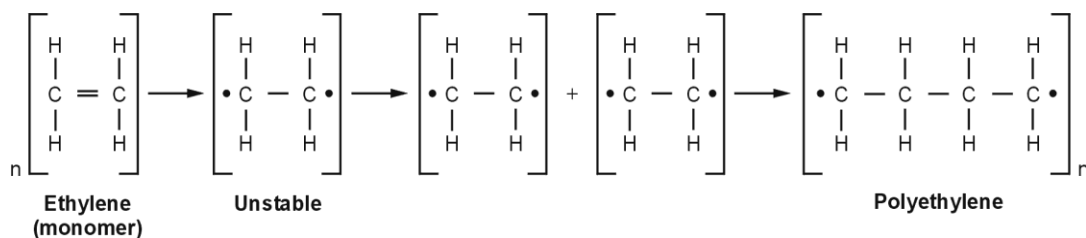

### Properties

- 1) High Density Polyethylene (HDPE) has high tensile strength, high density, it is relatively brittle and has low impact strength. It has low moisture absorption.
- 2) Low Density Polyethylene (LDPE) has low density, low tensile strength, less brittle. It has low moisture permeability.

### Applications

- 1) High density polyethylene is used in products and packaging such as water pipes, toys, detergent bottles.
- 2) Low density polyethylene is used for both rigid containers and plastic film applications, such as plastic bags and film wrap.

For example: in orthopaedic products, in consumer packaging bags, bottles and liners.

#### b) Synthesis of Polyvinyl Chloride (PVC)

It is prepared by heating vinyl chloride in presence of catalyst benzoyl peroxide or  $\text{H}_2\text{O}_2$ .

### Properties

- 1) It is chemically inert.
- 2) It is colourless, odourless
- 3) It has excellent resistance to water.

- 4) It is non-inflammable.
- 5) It is resistant to light and atmospheric oxygen.
- 6) It has excellent resistance to aqueous solutions, but it is attacked by stronger solvents such as aromatic hydrocarbons, ketones, esters, chlorinated solvents etc.

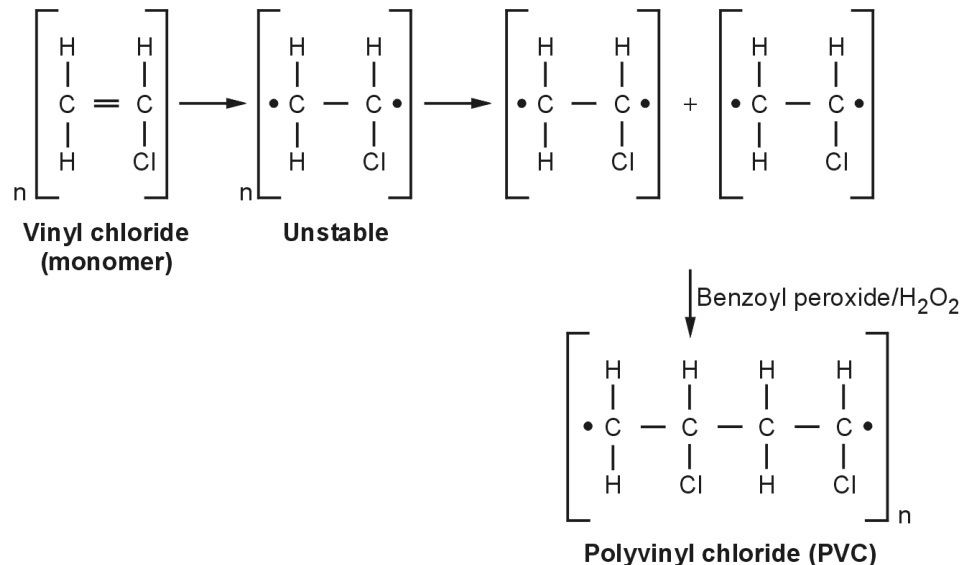

### Applications

- 1) Plasticized PVC is used for making continuous sheets used for packing rain-coats, curtains, table cloths, electrical insulation, bottles, door and window components, film and fabric coatings, radio components, chemical container.
- 2) Unplasticized PVC has high rigidity and superior chemical resistance. It is used for tank linings, light fittings, safety helmets, cycle and motor cycle mudguards, refrigerator components.

### c) Synthesis of Teflon (Polytetrafluoroethylene) (PTFE)

It is obtained by polymerization of tetrafluoroethylene in presence of catalyst benzoyl peroxide.

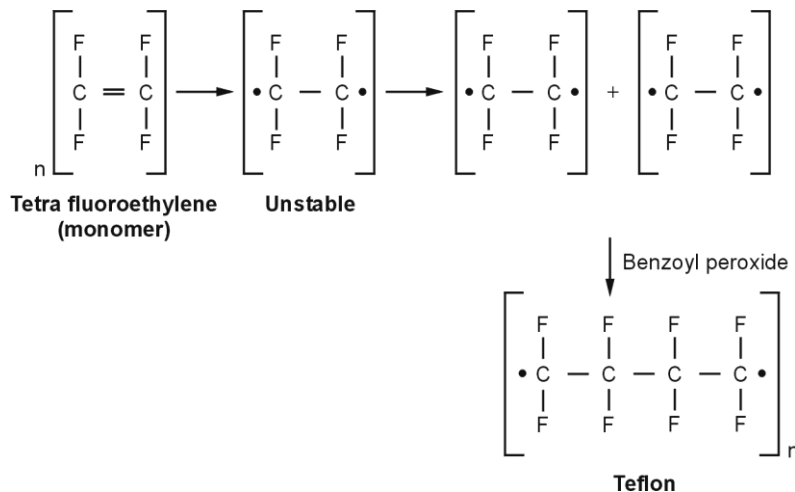

### Properties

- 1) It has high molecular weight.
- 2) It has low coefficient of friction.
- 3) It has low chemical reactivity.
- 4) It is resistance to water, alcohol.
- 5) It is harder and stronger than the other polymers.

### Applications

- 1) It is used in containers and pipework for reactive and corrosive chemicals.
- 2) It is used as an insulating material for motor, transformers, cables, wires etc.
- 3) It is used for making gaskets, tank linings, packings.
- 4) It is commonly used as a graft material in surgical interventions.

### d) Synthesis of Polystyrene (PS)

It is prepared by polymerization of styrene in presence of catalyst benzoyl peroxide.

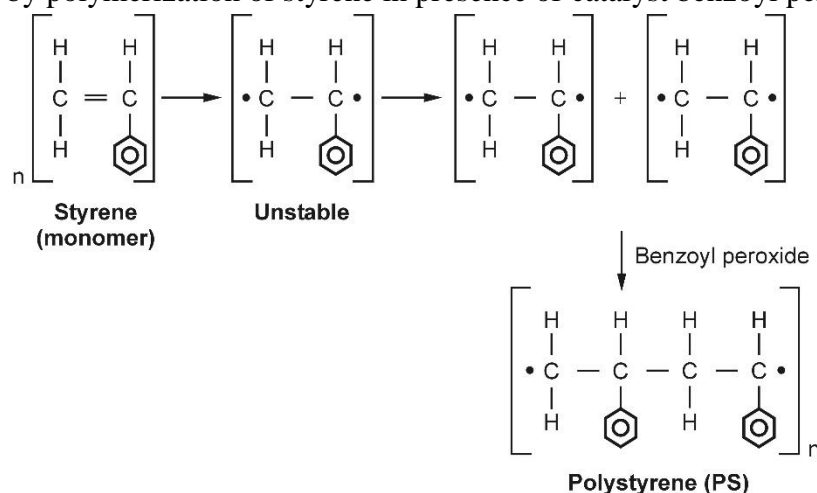

### Properties

- 1) It is transparent, hard and brittle.
- 2) It has low melting point.
- 3) It is a very good electrical insulator.
- 4) It has excellent optical clarity.
- 5) It has good chemical resistance to diluted acids and bases.
- 6) It can be easily moulded.

### Applications

- 1) It is used in food packing, optical, electronic, medical and automotive parts.
- 2) It is used for making the products like dining utensils, plastic cups, housewares, toys, CD cases, cosmetic containers, covers and fixtures.
- 3) It is used for making battery cases, refrigerator parts etc.

**e) Synthesis of phenol formaldehyde (Bakelite)**

It is prepared by polymerization of phenol and formaldehyde in presence of acidic or alkaline catalyst.

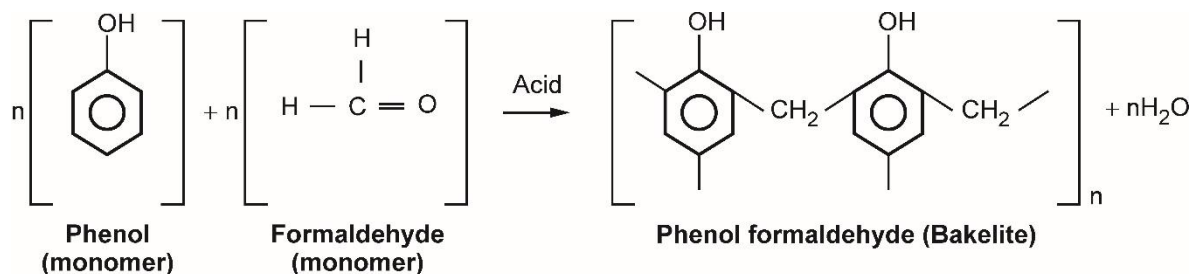
**Properties**

- 1) It is hard, rigid, non-flexible and brittle.
- 2) It is resistant to heat, scratches and destructive solvents.
- 3) It is resistant to electricity.
- 4) It can withstand very high temperature.

**Applications**

- 1) It is used for making, radio, telephone casings, plugs, switch boards etc.
- 2) It is used for making sheets, rods and tubes.
- 3) It is used as an adhesive.
- 4) For impregnating fabrics, wood and paper.
- 5) For making bearings, used in propeller shafts for paper industry and rolling mills.

**f) Synthesis of epoxy resin**

It is prepared by condensation of bis-phenol and epichlorohydrin in presence of alkaline catalyst.

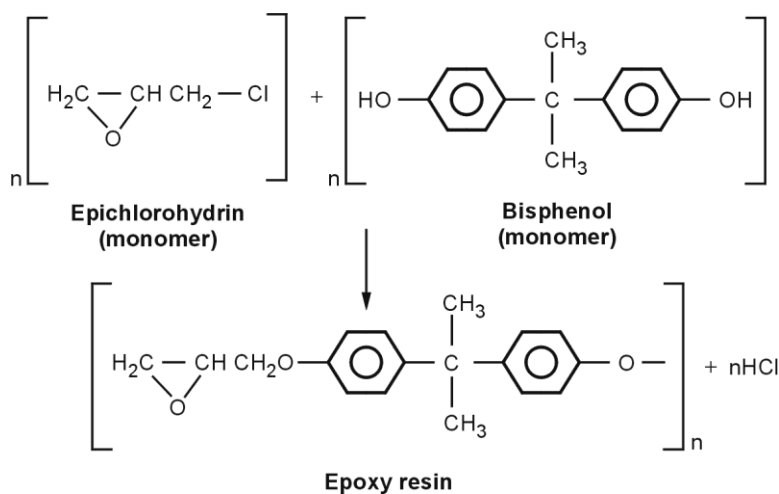
**Properties**

- 1) It is highly resistant to water, acids, bases and solvents.
- 2) It has excellent adhesion property.

3) Epoxy resin is thermosetting resin characterised by toughness, adhesion, corrosion resistance.

### Applications

- 1) It is used for metal coatings, use in electrical and electronic components / LED, high tension electrical insulators.
- 2) It is used in industrial floorings, adhesives and solders.
- 3) Moulds made from epoxy resins used for the production of components for aircrafts and automobiles.
- 4) It is used for surface coatings and gas storage vessels.

### Distinguish between addition polymerization and condensation polymerization

**Table 6.6**

Sr.No.	Addition polymerization	Condensation polymerization
1.	It is a process in which the monomers of same types undergo repeated addition to form long chain polymer without elimination of simple molecules like H <sub>2</sub> O, HCl etc.	It is a process in which the monomers of different types joined together by condensation forming a large polymer with the elimination of simple molecules like H <sub>2</sub> O, HCl, NH <sub>3</sub> etc.
2.	For addition polymerization, monomer should contain at least one C=C double bond.	For Condensation polymerization, the monomer should contain more than one functional group so as to enable intermolecular reaction.
3.	Plastics obtained by addition polymerization have of linear long chain structure.	Plastics obtained by condensation polymerization have of three dimensional network structures.
4.	Plastics obtained by addition polymerization are joined by weak covalent bond.	Plastics obtained by condensation polymerization are joined by strong covalent bonds.
5.	Plastics obtained by addition polymerization are soluble in organic solvents.	Plastics obtained by condensation polymerization are insoluble in organic solvents.
6.	For example: Formation of polyethylene (Polythene) from ethylene.	For example: Formation of Bakelite from phenol and formaldehyde.

## 6.6 Adhesive

### Significance:

Adhesives are the social substances capable to joined permanently two surfaces, by an adhesive process. This process involves two dissimilar bodies being held in intimate contact such that mechanical force or work can be transferred across the interface. Adhesives are growing more important in industrial products, in the construction industry, in sports and leisure articles, and in

many other segments. Almost 14 million tonnes of adhesives are consumed worldwide. According to the latest study adhesive revenues will rise worldwide by 3.6% per year until 2024.

**Definition:** “Any substance applied to one or both surfaces of two separate items that binds them together and resist their separation is called adhesives.”

### 6.6.1 Characteristics of Adhesives

- 1) It has ability to bind different materials together.
- 2) It is highly resistance to temperature.
- 3) It is highly resistance to chemicals.
- 4) It is resistance to moisture.
- 5) It possesses good adhesion property.
- 6) It has high resistance to stress or load.
- 7) It is highly resistance towards insects, fungi.

### 6.6.2 Classification of Adhesives

#### a) Classification of adhesives by structure

##### i) Thermosetting synthetic adhesives

These are formed by condensation polymerization and consist of a three dimensional network structure. They possess good adhesion property.

##### Examples

- **Phenol formaldehyde resin:** Used for making water proof plywoods, laminates, in aircraft and ship building industry.
- **Urea formaldehyde resin:** Used for wooden surfaces, plywoods, laminates, in aircraft and ship industry.
- **Polyesters:** For making laminated glass and cloth.
- **Epoxy resin:** For bonding glass, metallic and ceramic articles, in air-craft industry.
- **Silicon resins:** For bonding metals, ceramics, plastics, rubber etc.

##### ii) Thermoplastic synthetic adhesives

Thermoplastics are formed by addition polymerization and consist of a linear structure. It becomes soft when heated and hardens when cooled.

##### Examples

- **Cellulose derivatives:** Used in cloth and footwear industry.
- **Acrylics:** Used in bonding cloths, paper, glass, leather etc.
- **Polyvinyl (like PVC, Polyvinyl acetate):** Used for bonding non-porous surfaces, in the sealing operation in food industry.

#### b) Classification of adhesives by origin

##### i) Natural adhesives

Natural adhesives are extracted from the natural sources such as plants and animals.

### Examples

- **Shellac resin:** Used in making belts, conveyers, etc.
- **Asphalt:** Used in bonding paper, cloth and for metal bonding.
- **Animal glues:** Used in manufacturing furniture, radio cabinets, card boxes etc.
- **Vegetable based glues or protein glues:** Used for common adhesive jobs like paper crafts, posters to the walls of buildings, scrapbooking etc.
- **Starch adhesives:** Used for manufacturing envelopes, stamps, note-books, binding books etc.

### ii) Synthetic adhesives

Synthetic adhesives are designed and manufactured by man. These adhesives are not found in nature. These are the most widely used adhesives in the various sectors because their mechanical, physical and chemical properties are far superior to natural adhesives.

### Examples

- Polyvinyl acetate and synthetic resin are used for woodwork glue.
- Epoxy resin - used for joining metals and plastics.
- Contact adhesive - is used for joining polystyrene and fabrics and for fixing plastic laminates to a wooden base.
- Acrylic polymer adhesive - used in fabricating acrylic plastics, their emulsion used in fabric leather coating.

## 6.7 Lubricant:

### Significance:

The primary function of the industrial lubricant is to avoid metal contact amongst the tools or finished components. Industrial lubricants exhibit good corrosion protection properties and help to extend the life of equipment. Lubricants are widely utilised in energy, textile, chemical, construction and infrastructure sectors for engine oil, hydraulic oil, bearings and wire rope applications across the industrial sector. The global market growth is attributed to the rising demand for industrial lubricant in developed and developing economy.

**Lubricant:** In any type of machinery, there is a constant rubbing of surfaces of moving, sliding or rolling parts, as a result of which there develops a resistance to their movement. This resistance is called friction. The friction causes a lot of wear and tear of surfaces; a large amount of heat energy is dissipated in the form of heat which would decrease the efficiency of the machine. Moreover, the moving parts gets heated up and deform i.e. change their shape. The frictional resistance can be minimised by introduction of a suitable substance between two moving parts, which forms a thin layer in between them.

“A substance reduces the frictional resistance between moving parts called as a lubricant”.

**Lubrication:** The process of reducing frictional resistance between moving parts / surfaces is called lubrication.

### Characteristics of Lubricants:

The good lubricant should possess following characteristics:

1. It should maintain oil film between the moving parts of machine.



2. It should withstand high pressure between the moving parts.
3. It should not attack the metal surface.
4. It should not volatilize excessively.
5. It should retain fluidity at entire operation temperature condition, even at low temperature.

### **Functions of Lubricants:**

1. The primary function of lubricant to keep friction, wear and heat from affecting the sliding surfaces by providing a layer of liquid between the surfaces.
2. Cutting fluids have low viscosity, because of low viscosity they can easily fill in the cracks formed on the work piece.

### **6.7.1 Classification of Lubricants;**

According to their physical state lubricants are classified into three main classes.

- 1) Solid lubricants
- 2) Semisolid lubricants
- 3) Liquid lubricants

#### **1) Solid lubricants:**

Solid lubricants are used either in the form of dry powder or mixed with water or oil. Solid lubricants are used where the load is too high; the entry of dust particles is undesirable. They are especially useful at high and low temperatures, in high vacuums and in other applications where oil is not suitable. Examples: Graphite, molybdenum disulphide, hexagonal boron nitride, tungsten disulphide, soapstone, talc, mica, polytetrafluoroethylene, etc.

#### **Applications of solid lubricants:**

1. They resist being squeezed out and are useful under heavy load conditions.
  2. They are useful in inaccessible parts where the supply of lubricants cannot easily be renewed.
- Examples-

- **Graphite:** Graphite is widely used as a solid lubricant because of its low cost and excellent lubricating action. Graphite is used either in powdered form or as suspension in oil or water.

Applications:

1. It is used in air compressors, food industry and railway track joints.
  2. They are used in brass instrument valves, open gear, ball bearings, machine shop works etc.
- **Molybdenum disulphide:** It is used up to 400 °C. It's fine powder may be sprinkled on surfaces sliding at high velocities. It is also used along with solvents and in greases.

Applications:

1. It is used in paint as a pigment.
2. It is used as a catalyst in chemical reactions.

#### **2) Semisolid lubricants**

Greases, Vaseline, waxes are the semisolid lubricants. The most widely used semisolid lubricant is grease. They contain thickening agents like soaps of sodium, calcium, lithium or aluminium mixed with mineral or synthetic liquid lubricant. The composition of greases is generally 80 %

mineral or synthetic oil, 10 % soaps and 10 % additives such as rust inhibitor, antioxidants, metal deactivator, antiwear etc.

### **Applications of semisolid lubricants:**

1. It is used in high pressure applications and during metal cutting where liquid lubricants cannot be retained.
2. Greases are used where oil drip is undesirable because of heavy pressure.

#### **Type of Greases:**

- **Lithium based greases:** These are prepared by mixing petroleum oil and lithium soaps.
- **Sodium based greases:** These are prepared by mixing petroleum oil and sodium soaps.
- **Cup greases:** These are prepared by mixing petroleum oil and calcium soap.
- **Axle greases:** These are prepared by adding lime or any heavy metal hydroxide to resin and fatty oils.

### **3) Liquid lubricants:**

These are mainly lubricating oils, which form a thin continuous film between the metal surfaces and reduce friction. They are used as cutting fluids in cutting, grinding, trading and drilling of the metals. Cutting fluids are used in machining operations where friction is very high because of close contact between the work piece and the tool.

Applications:

1. Liquid lubricants are used in medicines.
  2. They are used in machinery as engine oils, compressor oils, gear oils and piston oils.
  3. They are used as hydraulic, brake and gear box fluids.
- **Water:** It can be used as such or in combination with one of the base oil. It is commonly used in milling and lathe turning.
  - **Mineral oil:** It is obtained from the crude petroleum oil.  
Example: paraffin's, naphthalene is most widely used.
  - **Animal oil:** These are obtained from the animal sources.  
Example: Whale oil: Obtained by distillation of whale.  
Lard oil: Obtained from the kidney, intestines and fat of pigs.  
Tallow oil: Prepared from the fat of cattles.  
Neat foot oil: Obtained by boiling fat of neat with water.
  - **Vegetable oil:** These oils are obtained from the vegetable sources.  
Example: Olive oil, Palm oil, Castor oil, Hazel nut oil, etc.
  - **Blended oils:** When mineral oils are mixed with animal or vegetable oils, the mixture is called blended oils.
  - **Synthetic oils:** These are chemically prepared compounds. These are very effective in severe conditions and used for applications where petroleum products are inadequate or where special characteristics such as long life, improved equipment efficiency or non-flammability is necessary.

**Examples:** Polyphenyl ethers, Silicate esters, Phosphate esters, Polyalkaline glycols, Chlorofluoro carbons, Fluoro silicones.

Applications:1) They are used in turbines and vacuum pumps.

2) They are used in semiconductor devices.

3) They are used in rocket motors, submarines

4) Silicate esters are used for low temperature refrigeration compressor lubrication.

### **Selection of lubricants:**

The selection of suitable lubricant for a particular purpose is certainly made on the basis of conditions of service and its own properties. The principle considerations of service requirements are:

- Temperature of operation
- Pressure between moving parts
- Speed of moving parts
- Nature of friction surface
- Presence of moisture
- Type of lubrication system

### **Selection of lubricant for gears:**

The gears are generally subjected to high pressure. Therefore, the lubricant used should possess following properties.

- It must possess good oiliness
- Should have anti foaming property.
- It should have high load carrying capacity.
- It should have low adsorption capacity towards dust particles.

Example- Thick mineral oils compounded with some additives such as metallic soaps and chlorine, Sulphur or phosphorous compounds.

### **Selection for cutting tools:**

Metal cutting tools, when used for performing any machining operation such as cutting, sawing, turning, boring, drilling etc. require the use of certain oils known as cutting oils.

Therefore, the lubricant used should possess following properties.

- It should be stable at high temperature.
- It must have the capability to remove the heat from the friction and the abrasion of wear particles away from the load-carrying zone as soon as it is formed.
- It should provide lubrication.
- It should prevent the corrosion of finished product.

Example- Liquid lubricants are used for cutting tool.

### **Selection for steam turbine:**

The problem of efficiently lubricating steam turbine is also somewhat difficult, as the lubricating oil is exposed to high temperature and oxidizing conditions. The oil film under such conditions

deteriorates very rapidly. The leakage of steam and cooling water may occur, which may form emulsion and sludges, restricting proper circulations.

Solid lubricants are used for steam turbine.

### **6.7.2 Properties of Lubricants**

#### **1) Viscosity**

Viscosity is a measure of fluid's resistance to flow at a given temperature.

The greater the resistance to flow, the higher is the fluid's viscosity. Low viscosity liquids are used for delicate instruments, which are working with high speed and light load like watches, clocks, sewing machines etc. High viscosity liquids are used for heavy machines, which are working with heavy load and slow speed like tractor, concrete mixture, rail track joints etc.

#### **2) Viscosity index**

It is a measure for the change of viscosity with variations in temperature.

The viscosity of liquids decreases as the temperature increases and the surfaces will come in contact with each other, thereby friction increases. The viscosity of liquids increases as the temperature decreases and the lubricant will require a large amount of energy to move on the rubbing surfaces, thereby friction increases.

A good lubricant is that whose viscosity does not change with temperature.

#### **3) Oiliness**

It is the power of an oil to maintain a continuous film at slow speed or high load while used as a lubricant.

Low viscosity liquids having high oiliness than high viscosity liquids. Lubricants possessing high oiliness form a continuous oil-film which does not collapse. Animal and vegetable oils are superior in oiliness than mineral oils. The oiliness of mineral oils can be increased by addition of neutral glycerides or fatty acids or soluble soaps.

A good lubricant should have sufficient oiliness, so that it maintains a continuous film between moving parts and reduces friction.

#### **4) Flash point and fire point**

##### **Flash point**

Definition: "The lowest temperature at which oil begins to give enough vapours which gives momentary flash of a light, when flame is applied to it is called as flash point."

##### **Fire point**

Definition: "The lowest temperature at which oil gives enough vapours which catch fire and burn continuously for 5 seconds, when flame is applied to it is called as fire point."

The flash and fire points are useful in determining a lubricants volatility and fire resistance. The lubricant having low flash and fire point will catch fire readily which causes damage to life and property of a factory.

A good lubricant should have high flash and fire point.

#### **5) Volatility**

It is the property of a lubricant to evaporate and loss its characteristics.

A highly volatile lubricant can evaporate even at lower temperature and in this case more lubricant is consumed by the machinery and lubrication process will be a costly.

A good lubricant should have low volatility.

### 6) Cloud point and pour point

#### Cloud point

Cloud point of lubricant is the temperature below which wax in the lubricant tends to form a cloudy appearance.

#### Pour point

Pour point of lubricant is the lowest temperature at which lubricant can flow and below which the lubricant tends to freeze or ceases to flow.

A good lubricant should have high cloud point and pour point.

In cold weather conditions, certain additives are added to it to keep its cloud point and pour point higher.

### 7) Acidity or neutralization number

The mass of potassium hydroxide (KOH) in milligrams that is required to neutralize acid in one gram of oil is called acidity or neutralization number.

It is a measure of the amount of carboxylic acid group in a chemical compound such as fatty acid or in a mixture of compounds. A known amount of oil sample dissolved in organic solvent like ethanol. It is then titrated with a solution of potassium hydroxide (KOH) of known concentration and phenolphthalein as an indicator. An oil-fat acidity, triglycerides are converted into fatty acids and glycerol.

If the lubricant contains free acids, it causes the corrosion of metal. A good lubricant is that which does not contains free acids.

### 8) Saponification value

The number of milligrams of potassium hydroxide (KOH) required to saponify 1 gram of oil / fat is called saponification value.

The long chain fatty acids found in fats have a low saponification value because they have relatively less number of carboxylic functional groups per unit mass of the fat as compared to short chain fatty acids. If more number of milligrams of KOH are required to saponify N grams of oil / fat, then there are more number of moles of the fat and the chain length are relatively small.

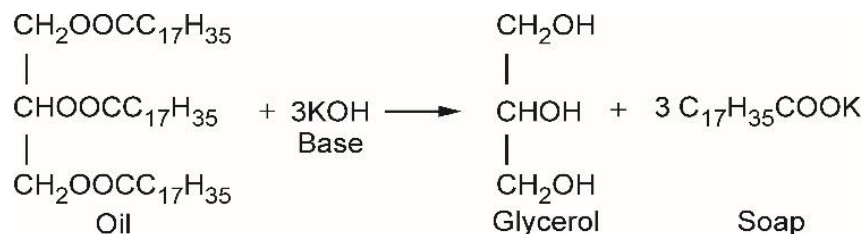

A good lubricant should have moderate saponification value.

### 9) Emulsification

When oil mixed with water, the mixture is called emulsion and the process is known as emulsification. The emulsion absorbs dust particles present in the surroundings which causes abrasion of the metals in contact and hence the lubricating action of the oil is spoiled.

A good lubricant does not form any emulsion and if it formed, it should break quickly.

### 6.7.3 Applications of Lubricants

- 1) Lubricants are used to reduce friction between surfaces.
- 2) In machinery as engine oils, compression oil, gear oils, piston oils.
- 3) These are used to reduce the wear and tear of the moving parts.
- 4) These are used to reduce the heat generation.
- 5) These are used to reduce the noise and vibrations.
- 6) Liquid lubricants are used in medicines.
- 7) These are used in the soap and paint industries.
- 8) These are used as a rust and corrosion inhibitor.
- 9) It is used as a demulsifying and emulsifying agents.
- 10) These are used as antiwear, antioxidants and antifoaming agents.

### Multiple choice questions:

- 1) Select the polymer from the following options which do not softened on heating.
  - a) PVC
  - b) Bakelite (Phenol formaldehyde resin)
  - c) polyethylene
  - d) All the above
  
- 2) \_\_\_\_\_ pigment gives white colour to the paint.
  - a) Chromium oxide
  - b) Zinc oxide
  - c) Ferric oxide
  - d) Brown umber
  
- 3) The function of pigment is \_\_\_\_\_.
  - a) reduces the fluidity of paint
  - b) improve the drying quality of paint
  - c) prevent gelling and skinning of the paint film
  - d) provides opacity to the paint
  
- 4) A thermoplastic polymer is formed by the phenomenon of \_\_\_\_\_.
  - a) addition polymerization
  - b) condensation polymerization
  - c) Crystallization
  - d) None of above
  
- 5) Select the adhesive which is used in the sealing operation in food industry \_\_\_\_\_.
  - a) cellulose derivatives
  - b) silicon resins
  - c) epoxy resins
  - d) Polyvinyl

### Answers:

Question	Q. 1	Q.2	Q.3	Q.4	Q.5
Answer	b	b	d	a	a

## References used for learning manual:

### Websites:

1. [www.chemistryteaching.com](http://www.chemistryteaching.com)
2. [www.visionlearning.com](http://www.visionlearning.com)
3. [www.chem1.com](http://www.chem1.com)
4. [www.onlinelibrary.wiley.com](http://www.onlinelibrary.wiley.com)
5. [www.rsc.org](http://www.rsc.org)
6. [www.chemcollective.org](http://www.chemcollective.org)
7. <https://www.infoplease.com/encyclopedia/science/tech/terms/lubrication/application-of-lubricants>
8. <https://www.globalspec.com/reference/38787/203279/applications-of-lubricants>
9. <https://www.globalspec.com/reference/38787/203279/applications-of-lubricants>
10. <https://onlinelibrary.wiley.com/doi/pdf/10.1002/jsl.3000010205>
11. <https://www.globalspec.com/reference/38787/203279/applications-of-lubricants>
12. <https://shodhganga.inflibnet.ac.in/bitstream/10603/23460/6/06.%20chapter%20-%20iv.pdf>

### Text Books:

1. Engineering Chemistry By Dara S.S ISBN: 8121997658; 2013.
2. Engineering Chemistry By Jain and Jain ISBN: 9352160002; 2015.
3. Textbook of Basic chemistry, Technical Publication By Dr. Kashmiri A. Khamkar, V.M.Gokhale , C.S.Raut. ISBN: 9789333214810.

### MOOCs:

1. <https://www.youtube.com/watch?v=n1X90QYoYYA>
2. <https://www.youtube.com/watch?v=7Gb3sidzF0g>
3. <https://www.youtube.com/watch?v=kBgHPfkGbmK>
4. <https://www.youtube.com/watch?v=rBmPhoEb1lQ>
5. <https://www.youtube.com/watch?v=n1X90QYoYYA>
6. <https://www.youtube.com/watch?v=HTIzwP8BKC8>